

EVO II  **640T V3**

SCHNELLSTARTANLEITUNG
GUIDE DE DÉMARRAGE RAPIDE
QUICK START GUIDE

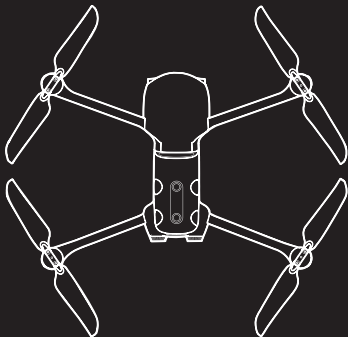

AUTEL
ROBOTICS

1. Übersicht

Der EVO II Dual V3 hat eine Höchstgeschwindigkeit von 20 m/s, eine maximale Flugzeit von 38 Minuten und eine Reichweite von 15 km (FCC). Der Controller besitzt ein 7,9"-Touchscreen mit einer Auflösung von 2048x1536 Pixel.

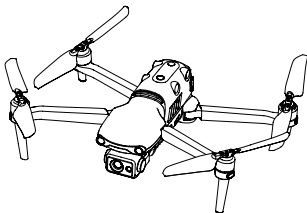

⚠ HINWEIS:

Lesen Sie bitte alle Dokumente vor der ersten Verwendung des Fluggeräts. Unsachgemäße Bedienung der Drohne kann zu Verletzungen, Schäden oder zum Erlöschen der Garantie führen.

2. Fluggerät

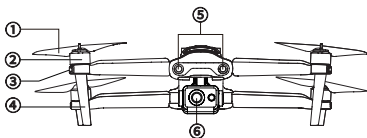

① Propeller

② Motoren

③ Led-Anzeigen (vorn)

④ Landegestell

⑤ Sichtsystem (vorn)

⑥ Gimbal-Kamera

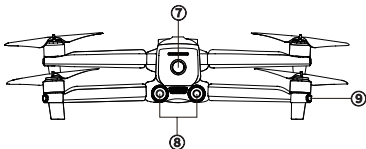

⑦ Ein-/Austaste

⑨ Led-Anzeigen (hinten)

⑧ Sichtsystem (hinten)

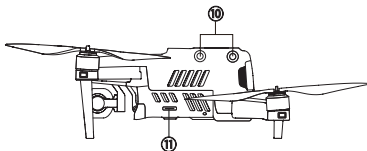

⑩ Sichtsystem (linke Seite)

⑪ Spalt für SD-Speicherkarte

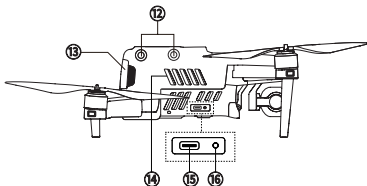

⑫ Sichtsystem (rechte Seite)

⑮ USB-Anschluss

⑬ Fluggerät-Batterie

⑯ LED/Taste zur Verbindung

⑭ Belüftungsöffnung

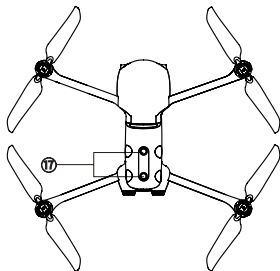

17 Sichtsystem (oben)

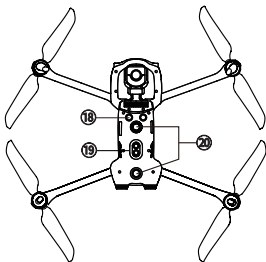

18 Ultraschallsensor

19 LED Fülllicht

20 Sichtsystem (unten)

3. Status-LEDs des Fluggeräts

Die vordere LED-Statusanzeige wird verwendet, um die Richtung des Fluggeräts anzuzeigen. Nachdem das Fluggerät eingeschaltet wurde, wird das rote Licht angezeigt. Die hintere Statusanzeige des Fluggeräts zeigt den aktuellen Status des Flugsteuerungssystems.

Statusanzeige:

Langsames Blinken: blinkt einmal alle 2 Sekunden

Schnelles Blinken: blinkt zweimal pro Sekunde

Abwechselndes Blinken: wechselt zwischen verschiedenen Farben

Color Key:

R – Red Color

G – Yellow Color

Y – Green Color

Status-LEDs des Fluggeräts	
Normaler Status	
RGY - Abwechselndes Blinken	Selbsttest des Systems
YG - Abwechselndes Blinken	Aufwärmphase
G - Langsames Blinken	Das Fluggerät ist in GPS-Modus
Warnungen	
Y - Langsames Blinken	Das Fluggerät ist in ATTI-Modus
Y - Schnelles Blinken	Keine Verbindung zwischen dem Fluggerät und der Fernsteuerung hergestellt
R - Langsames Blinken	Warnung für niedrige Batterie
R - Schnelles Blinken	Warnung für kritisch niedrige Batterie
R - Dauerhaft	Warnung für kritisch niedrige Batterie
RY - Abwechselndes Blinken	Kritisches Problem, IMU Fehler
Kompasskalibrierung	
Y - Schnelles Blinken	Start der Kompasskalibrierung
G - Dauerhaft	Kalibrierung erfolgreich
R - Dauerhaft	Kalibrierung fehlgeschlagen

4. Fernsteuerung

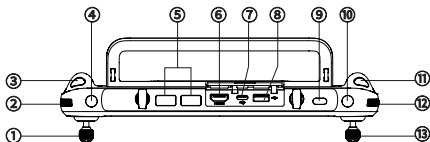

- | | |
|----------------------------|------------------------|
| ① Linker Befehlsstift | ⑧ USB Typ-A-Anschluss |
| ② Gimbal-Neigungswinkelrad | ⑨ Ein/Aus-Taste |
| ③ Videoaufnahme-taste | ⑩ Anpassbare Taste C2 |
| ④ Anpassbare Taste C1 | ⑪ Foto-Shutter-Taste |
| ⑤ Luftausgang | ⑫ * Zoom-Steuerrad |
| ⑥ HDMI-Anschluss | ⑬ Rechter Befehlsstift |
| ⑦ USB Typ-C-Anschluss | |

*Die Funktion kann sich ändern, bitte nehmen Sie die praktische Wirkung als Standard.

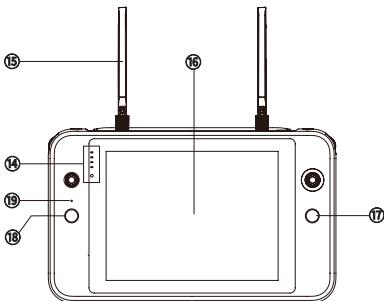

- | | |
|-------------------|-----------------------|
| ⑭ Batterieanzeige | ⑰ Pause-Taste |
| ⑮ Antenne | ⑱ Autostart/RTH-Taste |
| ⑯ Touchscreen | ⑲ Mikrofon |

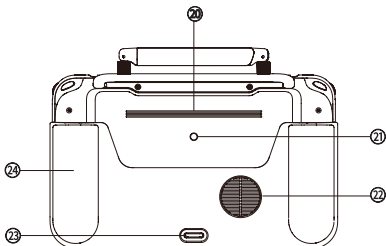

- ②① Lautsprecheröffnung
- ②① Stativ-Befestigungsloch
- ②② Entlüftung

- ②③ Unterer Haken
- ②④ Griffe

5. Aufladung

- (1) Fluggerät-Batterie: Stecken Sie das Ladekabel in den entsprechenden Anschluss.

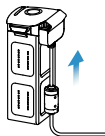

- (2) Fernsteuerung: Öffnen Sie die Schutzkappe am USB-Anschluss und stecken Sie das mitgelieferte Ladekabel ein.

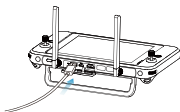

⚠ HINWEIS:

- Laden Sie die Batterie des Fluggeräts und der Fernsteuerung vor dem Flug auf.
 - Die vollständige Ladung der Batterie des Fluggeräts nimmt 90 Minuten in Anspruch. Für die Ladung der intelligenten Fernsteuerung brauchen Sie 120 Minuten.
-

6. Autel Explorer App

Sie können Autel Explorer von Google Play herunterladen.

7. PREPARING THE AIRCRAFT

- (1) Vor dem Einschalten des Fluggeräts stellen Sie sicher, dass der Gimbal-Schutz entfernt ist (je unten dargestellt).

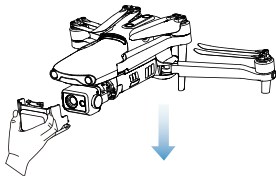

- (2) Klappen Sie die Arme und die Propeller auseinander.

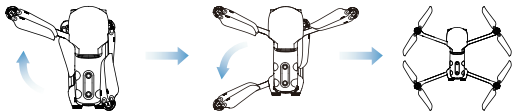

HINWEIS:

Schalten Sie das Fluggerät aus, bevor Sie die Arme auseinanderklappen. Klappen Sie die hinteren Arme und Propeller ein, dann die vorderen Arme.

8. Propeller

Die Propeller sind standardmäßig am Fluggerät befestigt. Folgen Sie diesen Anweisungen, wenn Sie die Propeller wieder einbauen müssen. Montieren Sie den Propeller mit weißer Markierung auf dem entsprechenden Motor mit weißer Markierung. Montieren Sie den Propeller ohne weiße Markierung auf dem entsprechenden Motor ohne weiße Markierung.

• Montage der Propeller

- (1) Stellen Sie sicher, dass das Fluggerät ausgeschaltet ist.
- (2) Montieren Sie den anpassenden Propeller auf den jeweiligen Motor.
- (3) Drücken Sie jeden Propeller und drehen Sie ihn in die Verriegelungsrichtung, bis er fest sitzt.

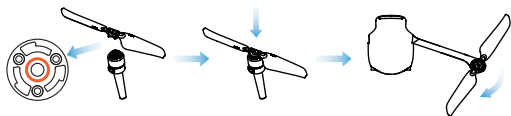

• Abnehmen der Propeller

- (1) Schalten Sie das Fluggerät aus.
- (2) Drücken Sie jeden Propeller und drehen Sie ihn in die Entriegelungsrichtung, um diesen abzunehmen.

Beschreibung

- ↻ Verriegelungsrichtung: Drehen Sie in die angegebene Richtung, um den Propeller zu verriegeln.
- ↺ Entriegelungsrichtung: Drehen Sie in die angegebene Richtung, um den Propeller zu entriegeln.

⚠ HINWEIS:

- Schalten Sie das Fluggerät aus, bevor Sie die Propeller montieren/abnehmen.
 - Die Propeller müssen unbeschädigt und gut befestigt sein.
-

9. Vorbereitung der Fernsteuerung

(1) Klappen Sie die Antenne aus, nehmen Sie die Steuerknüppel aus der Rückseite der intelligenten Fernsteuerung ab und montieren Sie sie in die entsprechenden Löcher.

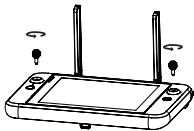

(2) Stellen Sie den Winkel der Antenne ein. Die optimale Position wird erreicht, wenn die Antennenfläche zum Fluggerät zeigt und wenn die Antenne und die Rückseite der intelligenten Fernsteuerung im Winkel von 180° oder 260° Grad stehen.

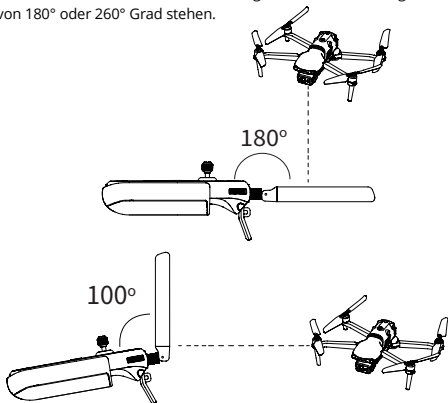

10. Einschalten

(1) Halten Sie die Power-Taste für 2 Sekunde gedrückt, um die Fernsteuerung einzuschalten.

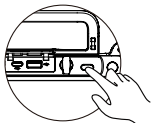

- (2) Halten Sie die Power-Taste für 3 Sekunde gedrückt, um das Fluggerät einzuschalten. Die Batterieanzeige wird den aktuellen Batteriestand des Fluggeräts anzeigen.

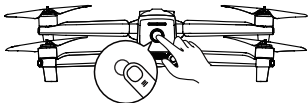

11. Start

- (1) Bewegen Sie gleichzeitig die Steuerhebel nach innen oder außen und halten Sie diese für 2 Sekunden.

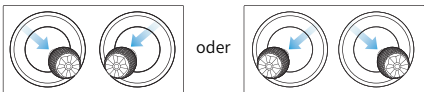

- (2) Drücken Sie den linken Steuerknüppel (Modus 2).



HINWEIS:

- Modus 2 ist der Standardsteuermodus des Smart Controllers. Mit dem linken Steuerhebel wird die Höhe und Flugrichtung und mit dem rechten Steuerhebel die Vor-, Rück- und Seitwärtsbewegung des Fluggeräts gesteuert.
 - Vor dem Start positionieren Sie das Fluggerät auf einer ebenen Fläche und halten Sie die Rückseite des Fluggeräts zu sich hin.
-

12. Bedienung der Steuerknüppel (Modus 2)

Linker Steuerhebel

Ansicht von links

Aufsteigen

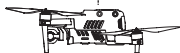

Nach oben drücken

Ansicht von links

Absteigen



Nach unten drücken

Ansicht von oben

Die Nase dreht sich nach links

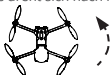

Nach links drücken

Ansicht von oben

Die Nase dreht sich nach rechts

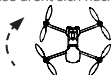

Nach rechts drücken

Rechter Steuerhebel

Ansicht von links

Vorwärts



Nach oben drücken



Ansicht von links

Rückwärts



Nach unten drücken



Ansicht von hinten

Links

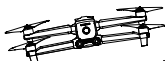

Nach links drücken



Ansicht von hinten

Rechts

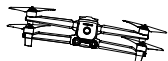

Nach rechts drücken



13. Technische Daten

Fluggerät	
Betriebsfrequenz des RF-Empfängers	902 bis 928 MHz (FCC); 2,4 bis 2,4835 GHz; 5,725 bis 5,850 GHz (Nicht-Japan); 5,650 bis 5,755GHz (Japan)
Sendeleistung (EIRP)	900MHz: FCC/ISED \leq 31dBm 2.4GHz: FCC/ISED \leq 32dBm; CE/MIC/SRRC/RCM \leq 20dBm 5.8GHz/5.7GHz: FCC/ISED/SRRC/MIC \leq 33dBm; CE/RCM \leq 14dBm
Fernsteuerung	
Betriebsfrequenz des RF-Empfängers	902 bis 928 MHz (FCC); 2,4 bis 2,4835 GHz; 5,725 bis 5,850 GHz (Nicht-Japan); 5,650 bis 5,755GHz (Japan)
Sendeleistung (EIRP)	FCC: \leq 33dBm CE: \leq 20dBm@2.4G, \leq 14dBm@5.8G/5.7G SRRC: \leq 20dBm@2.4G, \leq 33dBm@5.8G/5.7G

1. Vue d'ensemble

L'EVO II Dual 640T V3 a une vitesse de pointe de 20 m/s, un temps de vol maximum de 38 minutes et une distance de fonctionnement de 15 km. Le Radiocommande comporte un écran tactile de 7,9 pouces avec une résolution de 2048x1536 pixels.

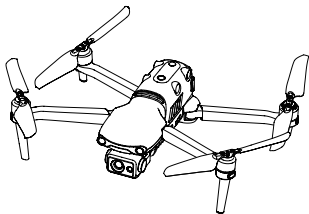

⚠ REMARQUE:

Veillez consulter toute la documentation pertinente avant votre premier vol. Un mauvais fonctionnement du drone peut entraîner des blessures ou des pertes, et la perte de tous les services de garantie applicables.

2. Appareil

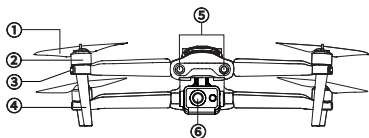

- ① Hélices
- ② Moteurs
- ③ Voyant LED avant

- ④ Train d'atterrissage
- ⑤ Système de vue avant
- ⑥ Caméra à nacelle

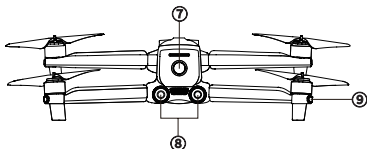

⑦ Bouton d'alimentation

⑨ Voyant LED arrière

⑧ Système de vue arrière

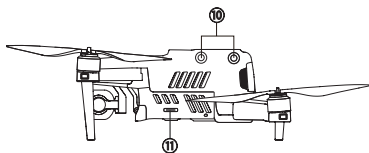

⑩ Système de vue gauche

⑪ Emplacement pour carte SD

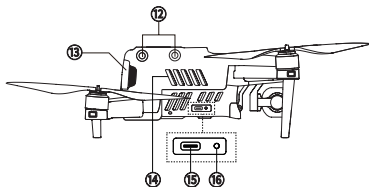

⑫ Système de vue droite

⑮ Port USB

⑬ Batterie de l'aéronef

⑯ Bouton d'appairage/
indicateur d'appairage

⑭ Grille de ventilation

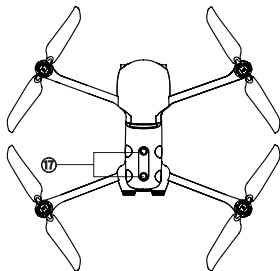

17 Système de vue haut

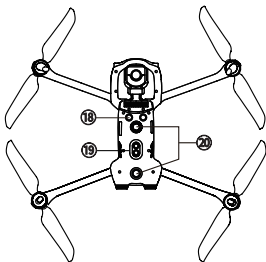

18 Capteur à ultrasons

20 Système de vue bas

19 Lumière de remplissage à LED

3. Voyants LED de vol

Le voyant d'état LED du nez de l'aéronef est utilisé pour indiquer la direction du nez de l'aéronef. Après la mise sous tension de l'aéronef, le voyant rouge s'affiche. Le voyant d'état de l'aéronef sur la queue indique l'état actuel du système de commandes de vol.

Voyant d'état:

Clignotement lent: clignote une fois toutes les 2 secondes

Clignotement rapide: clignote deux fois par seconde

Clignotement alterné: Clignote de manière alternée dans différentes couleurs

Farbe:

R – Rouge

G – Vert

Y – Jaune

État des voyants LED de vol	
État normal	
RGY- Clignotement alterné	Auto contrôle du système
YG- Clignotement alterné	Échauffement
G- Clignotement lent	L'aéronef est en mode GPS
Avertissements	
Y- Clignotement lent	L'aéronef est en mode ATTI
Y- Clignotement rapide	Aucune connexion entre l'aéronef et la radiocommande
R- Clignotement lent	Avertissement de batterie faible
R- Clignotement rapide	Avertissement de batterie très faible
R- Toujours allumé	Problème grave ou IMU anormal
RY- Clignotement alterné	La boussole est anormale, étalonnage nécessaire/interférence du magnétomètre
Étalonnage de la boussole	
Y- Clignotement rapide	Prêt à étalonner la boussole/l'aéronef est en train d'étalonner
G- Toujours lumineux	Étalonnage réussi
R- Toujours allumé	Étalonnage échoué

4. Radiocommande

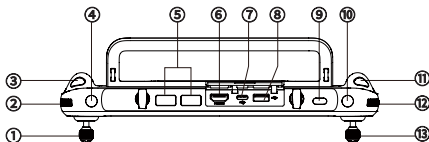

- | | |
|--|---------------------------------|
| ① Manette de commande gauche | ⑦ Port USB de type-C |
| ② Molette d'angle de tangage du cardan | ⑧ Port USB de type-A |
| ③ Bouton d'enregistrement vidéo | ⑨ Bouton d'alimentation |
| ④ Bouton configurable C1 | ⑩ Bouton configurable C2 |
| ⑤ Sortie d'air | ⑪ Bouton d'obturateur photo |
| ⑥ Port HDMI | ⑫ * Molette de commande du zoom |
| | ⑬ Manette de commande droite |

*La fonction pouvant changer, veuillez considérer l'effet pratique comme standard.

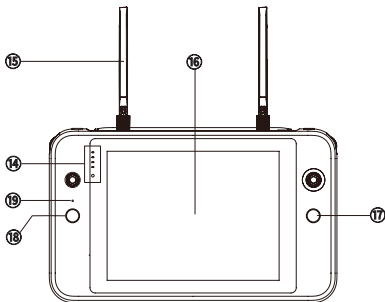

- | | |
|--------------------------|------------------------------------|
| ⑭ Indicateur de batterie | ⑰ Bouton pause |
| ⑮ Antenne | ⑱ Bouton Décollage automatique/RTH |
| ⑯ Écran tactile | ⑲ Microphone |

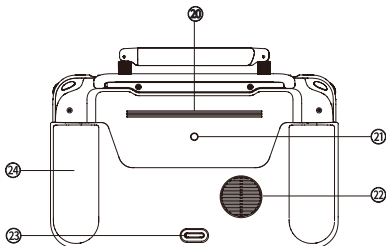

- ⑳ Trou du haut-parleur
- ㉑ Trou pour le montage du trépied
- ㉒ Événement d'air
- ㉓ Crochet inférieur
- ㉔ Poignées

5. Chargement

- (1) Batterie de l'aéronef: Insérez le câble de charge dans la fente de charge.

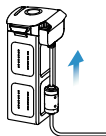

- (2) Radiocommande: ouvrez la porte sur le port USB et branchez le câble de charge fourni en dotation.

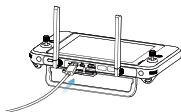

⚠ REMARQUE:

- Vérifiez toujours les batteries de l'aéronef et de la radiocommande avant de voler.
 - Il faut environ 90 minutes pour charger complètement la batterie de l'aéronef et 120 minutes pour charger la radiocommande.
-

6. Autel Explorer app

Vous pouvez télécharger Autel Explorer depuis Google Play.

7. Préparation de l'aéronef

- (1) Retirez le couvercle de protection de la nacelle avant d'allumer l'interrupteur d'alimentation de l'aéronef, comme indiqué sur la figure ci-dessous.

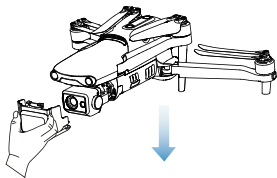

- (2) Dépliez les bras et les hélices.

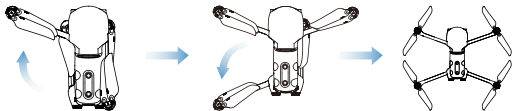

REMARQUE:

Avant de replier les bras, éteignez l'interrupteur d'alimentation de l'aéronef. Pliez les bras arrière et les hélices, puis repliez les bras avant.

8. Hélices

Par défaut, les hélices sont déjà installées sur l'aéronef. Si vous devez les réinstaller, reportez-vous aux instructions suivantes.

• Installation des hélices

- (1) Vérifiez que l'aéronef est hors tension.
- (2) Sélectionnez l'hélice qui correspond à chaque moteur.
- (3) Appuyez fermement sur l'hélice, puis tournez-la dans le sens de verrouillage pour que l'hélice soit bien installée.



• Démontage des hélices

- (1) Éteignez l'aéronef.
- (2) Appuyez fermement sur l'hélice, puis tournez-la dans le sens de déverrouillage pour retirer l'hélice.

Description

- 🔒 Direction de verrouillage: Tournez dans le sens indiqué pour fixer l'hélice.
- 🔓 Direction de déverrouillage: Faites tourner l'hélice comme indiqué pour la desserrer.

⚠️ REMARQUE:

- Avant d'installer ou de retirer l'hélice, mettez l'aéronef hors tension.
 - Portez des gants de protection lors de l'installation ou du retrait des hélices.
-

9. Préparation de la Fernsteuerung

(1) Dépliez l'antenne, détachez les manettes à l'arrière de la poignée de la radiocommande et vissez-les dans les trous de vis correspondants des deux côtés de l'écran.

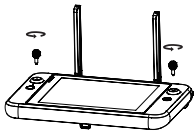

(2) Ajustez l'angle de l'antenne, et lorsque l'antenne et l'arrière de la radiocommande forment un angle de 180° ou 260° et que la surface de l'antenne fait face à l'aéronef, la qualité du signal de l'aéronef et de la radiocommande sera optimale.

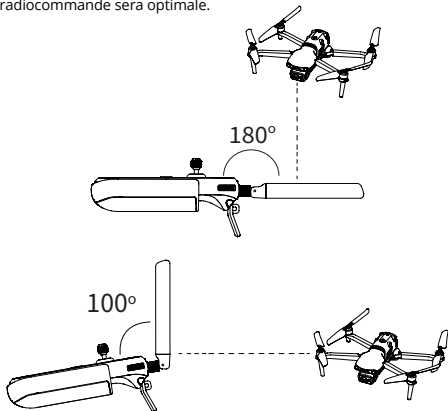

10. Mise sous tension

(1) Appuyez sur l'interrupteur d'alimentation pendant 2 secondes pour allumer la radiocommande.

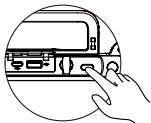

- (2) Appuyez sur le bouton d'alimentation pendant 3 secondes pour allumer l'aéronef. L'indicateur de batterie s'allumera pour afficher le niveau actuel de la batterie de l'aéronef.

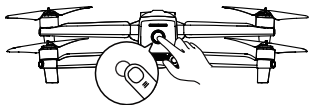

11. Décollage

- (1) Déplacez simultanément la manette de commande vers l'intérieur ou vers l'extérieur et maintenez la position pendant 2 secondes.

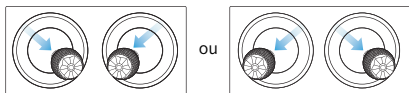

- (2) Poussez la manette de commande gauche (mode 2).



REMARQUE:

- Le mode 2 est le mode de contrôle par défaut du contrôleur intelligent. Le joystick de gauche contrôle l'altitude et le cap de l'aéronef, tandis que le joystick de droite contrôle les mouvements avant, arrière et latéraux.
 - Avant de décoller, veuillez placer l'aéronef sur une surface plane avec la queue tournée vers vous.
-

12. Contrôle de l'aéronef (mode 2)

Joystick de gauche

Vue de gauche

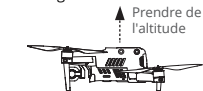

Vers le haut

Vue de gauche

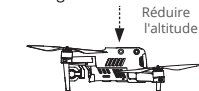

Vers le haut

Vue de dessus

Orienter le nez à gauche



Vers la gauche

Vue de dessus

Orienter le nez à droite



Vers la droite

Joystick de droite

Vue de gauche



Vers le haut



Vue de gauche

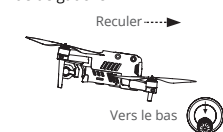

Vers le bas



Vue arrière



Vers la gauche



Vue arrière

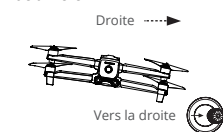

Vers la droite



13. Spécifications

Appareil	
Fréquence de fonctionnement	902~928 MHz (FCC); 2,4~2,4835 GHz ; 5,725~5,850 GHz (Hors Japon) ; 5,650~5,755 GHz (Japon)
Puissance de transmission (EIRP)	900MHz: FCC/ISED<=31dBm 2.4GHz: FCC/ISED<=32dBm; CE/MIC/SRRC/RCM<=20dBm 5.8GHz/5.7GHz: FCC/ISED/SRRC/MIC<=33dBm; CE/RCM<=14dBm
Radiocommande	
Fréquence de fonctionnement	902~928 MHz (FCC); 2,4~2,4835 GHz ; 5,725~5,850 GHz (Hors Japon) ; 5,650~5,755 GHz (Japon)
Puissance de transmission (EIRP)	FCC: ≤33dBm CE: ≤20dBm@2.4G, ≤14dBm@5.8G/5.7G SRRC: ≤20dBm@2.4G, ≤33dBm@5.8G/5.7G

1. OVERVIEW

The EVO II Dual 640T V3 brings excellent flight performance, achieving a top speed of 20m/s (45mph), 38-minute flight time, and an operating distance at 15km (9.32miles, FCC). The aircraft comes with a 7.9 inch touch-screen controller, boasts a 2048x1536 pixel resolution.

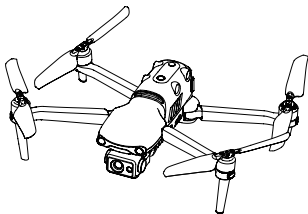

⚠ NOTE:

Please read all documentation before your first flight. Failure to operate the aircraft responsibly could lead to injury or damages, and may void any applicable warranty coverage.

2. AIRCRAFT

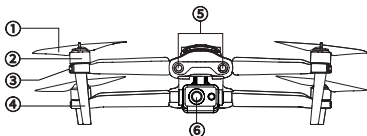

① Propellers

② Motors

③ Front LED Indicators

④ Landing Gear

⑤ Front Vision System

⑥ Gimbal Camera

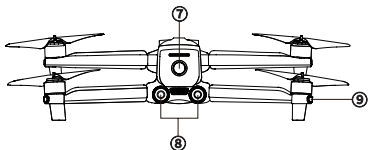

- ⑦** Power Button
- ⑨** Rear LED Indicators
- ⑧** Rear Vision System

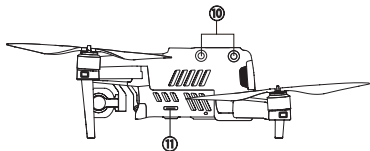

- ⑩** Left Side Vision System
- ⑪** SD Card Slot

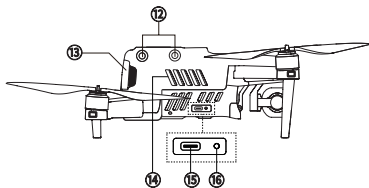

- ⑫** Right Side Vision System
- ⑮** USB-C Port
- ⑬** Aircraft Battery
- ⑯** Pairing Button / Pairing Indicator
- ⑭** Air Vent

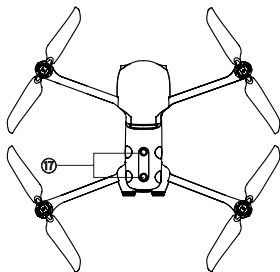

⑰ Upward Vision System

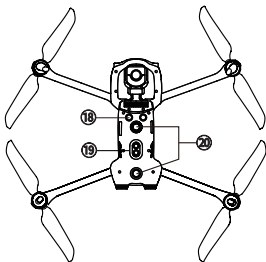

⑱ Ultrasonic Sensor

⑳ Downward Vision System

㉑ Downward Vision Lighting LED

3. FLIGHT LED INDICATIONS

A LED indicator is located on the end of each aircraft arm. The front LEDs will light up solid red to help you identify the direction of the aircraft's nose. The rear LEDs will display the current flight status of the aircraft. The chart below shows the meaning of each status indicator.

Indicator Key:

Slow Flashing: Flashes once every 2s

Fast Flashing: Flashes twice per second

Alternate Flashing: Alternates among different colors

Color Key:

R – Red Color

G – Yellow Color

Y – Green Color

Definitions of Indicator Status	
Normal	
RGY – Alternate Flashing	System self-test is activated
YG - Alternate Flashing	The aircraft is warming up
G – Slow Flashing	The aircraft is in GPS mode
Warning	
Y - Slow Flashing	The aircraft is in ATTI mode
Y - Fast Flashing	No connection between the aircraft and smart controller
R - Slow Flashing	Low Battery Warning
R - Fast Flashing	Critically Low Battery Warning
R – Solid Light	Critical problems, IMU error
RY – Alternate Flashing	Abnormal compass, calibration is required / Magnetometer interference
Compass Calibration	
Y - Fast Flashing	Be ready to calibrate the compass/ The aircraft is calibrating
G – Solid Light	Calibration is successful
R – Solid Light	Calibration is failed

4. REMOTE CONTROLLER

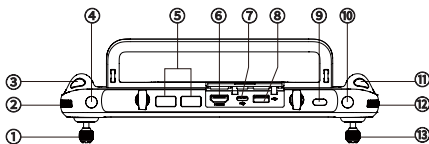

- ① Left Command Stick
- ② Gimbal Pitch Angle Wheel
- ③ Video Recording Button
- ④ Customizable Button C1
- ⑤ Air Outlet
- ⑥ HDMI Port
- ⑦ USB TYPE-C Port
- ⑧ USB TYPE-A Port
- ⑨ Power Button
- ⑩ Customizable Button C2
- ⑪ Photo Shutter Button
- ⑫ *Zoom Control Wheel
- ⑬ Right Command Stick

*The function may alter, please take the practical effect as standard.

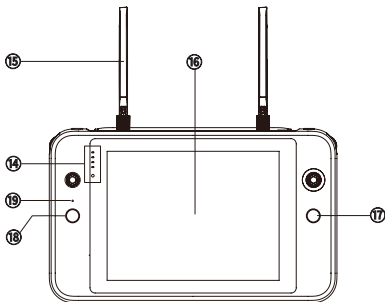

- ⑭ Battery Indicator
- ⑮ Antenna
- ⑯ Touch Screen
- ⑰ Pause Button
- ⑱ Auto-takeoff/RTH Button
- ⑲ Microphone

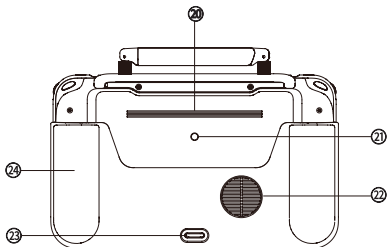

- ②① Speaker Hole
- ②② Tripod Mount Hole
- ②③ Air Inlet
- ②④ Bottom Hook
- ②⑤ Grips

5. CHARGING

- (1) Aircraft Battery: Plug the charging connector into the battery's charge port, and connect the other end to power adapter. Plug the power adapter into a power outlet (100-240V).

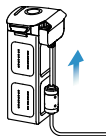

- (2) Controller: Connect the charging cable to the USB port at the top of the controller, and the other end to power adapter. Plug the power adapter into a power outlet (100-240V AC).

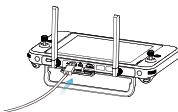

⚠ NOTE:

- Always fully charge the aircraft and smart controller battery before flying.
 - It takes approximately 90 minutes to fully charge the aircraft battery, and 120 minutes to charge the controller.
-

6. AUTEL EXPLORER APP

Search for 'Autel Explorer' from Google Play and install the app on your controller.

7. PREPARING THE AIRCRAFT

(1) Before powering on the aircraft, please remove the gimbal cover.

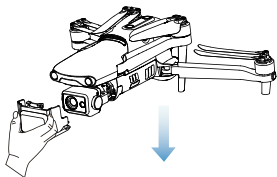

(2) Unfold the arms and propellers.

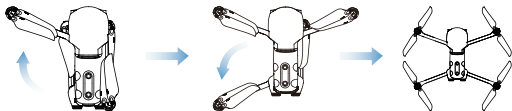

NOTE:

Power off the aircraft before folding the arms. Fold in the rear arms and propellers first, and then the front ones.

8. PROPELLERS

Because the propellers come attached to the aircraft, the following instructions apply if you need to reinstall propellers.

• Attaching the Propellers

- (1) Power off the aircraft.
- (2) Pair the propellers and corresponding motors according to the white mark.
- (3) Press each propeller down firmly and rotate in the lock direction to securely attach the propeller.

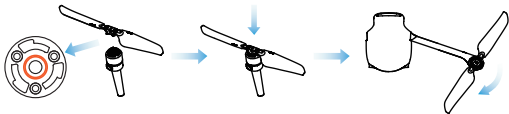

• Detaching the Propellers

- (1) Power off the aircraft.
- (2) Press each propeller down firmly and rotate in the unlock direction to detach the propeller.

LEGEND

 Lock Direction: Fasten the propeller by rotating it as indicated.

 Unlock Direction: Unfasten the propeller by rotating it as indicated.

NOTE:

- Power off the aircraft before attaching or detaching propellers.
 - Propellers must be undamaged and firmly attached.
-

9. PREPARING THE CONTROLLER

- (1) Unfold the antenna, detach the stick heads on the back of the controller handle, and screw them into the corresponding screw holes on both sides of the screen.

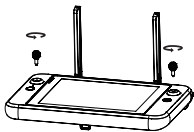

- (2) Adjust the antenna angle, and when the antenna and the back of the controller are at the angle of 180 or 260, and the antenna surface is facing the aircraft, the signal quality of the aircraft and controller will reach the optimal condition.

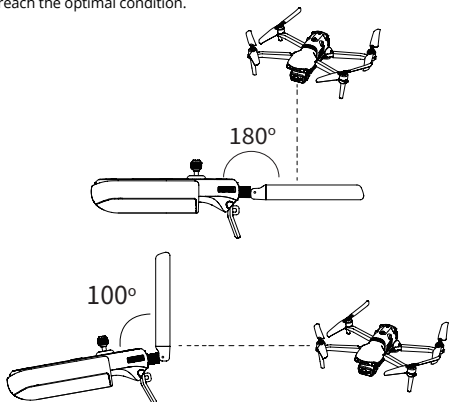

10. POWERING UP

- (1) Press and hold the power button for 2 seconds to turn on the controller.

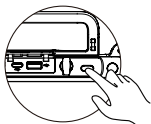

- (2) Press and hold the power button 3 seconds to turn on the aircraft. The current battery level will be clearly displayed.

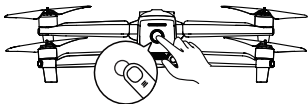

11. TAKE OFF

- (1) Start the motors by holding both command sticks for 2 seconds as shown below.

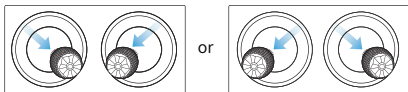

- (2) Push the left command stick slowly upward.



⚠ NOTE:

- The default control stick mode is mode 2. The left stick controls the altitude and heading of the aircraft, while the right stick controls the forward, backward and sideward movements.
 - Before takeoff, place aircraft on a level surface, stand well clear of the rear of the aircraft.
-

12. COMMAND STICK CONTROLS(MODE 2)

Left Command Stick

Left Side View

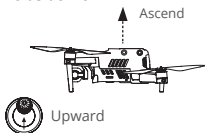

Left Side View

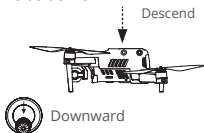

Top View

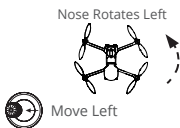

Top View

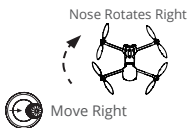

Right Command Stick

Left Side View

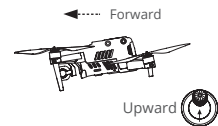

Left Side View

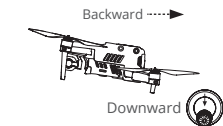

Rear View

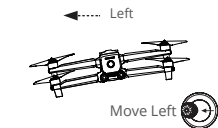

Rear View

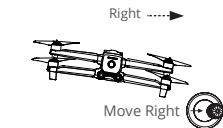

13. SPECIFICATIONS

Aircraft	
Operating Frequency	902~928MHz (FCC); 2.4~2.4835GHz; 5.725~5.850GHz (Non-Japan); 5.650-5.755GHz (Japan)
Transmission Power (EIRP)	900MHz: FCC/ISED≤31dBm 2.4GHz: FCC/ISED≤32dBm; CE/MIC/SRRC/RCM≤20dBm 5.8GHz/5.7GHz: FCC/ISED/SRRC/MIC≤33dBm; CE/RCM≤14dBm
Remote Controller	
Operating Frequency	902~928MHz (FCC); 2.4~2.4835GHz; 5.725~5.850GHz (Non-Japan); 5.650-5.755GHz (Japan)
Transmission Power (EIRP)	FCC: ≤33dBm CE: ≤20dBm@2.4G, ≤14dBm@5.8G/5.7G SRRC: ≤20dBm@2.4G, ≤33dBm@5.8G/5.7G

FCC and ISED Canada Compliance

This device complies with part 15 of the FCC Rules and ISED Canada licence-exempt RSS standards. Operation is subject to the following two conditions:

- (1) This device may not cause harmful interference, and
- (2) this device must accept any interference received, including interference that may cause undesired operation.

Le présent appareil est conforme aux CNR d'ISED Canada applicables aux appareils radio exempts de licence. L'exploitation est autorisée aux deux conditions suivantes :

- (1) l'appareil ne doit pas produire de brouillage, et
- (2) l'appareil doit accepter tout brouillage radioélectrique subi, même si le brouillage est susceptible d'en compromettre le fonctionnement.

NOTE:

This equipment has been tested and found to comply with the limits for a Class B digital device, pursuant to part 15 of the FCC Rules. These limits are designed to provide reasonable protection against harmful interference in a residential installation. This equipment generates, uses and can radiate radio frequency energy and, if not installed and used in accordance with the instructions, may cause harmful interference to radio communications. However, there is no guarantee that interference will not occur in a particular installation. If this equipment does cause harmful interference to radio or television reception, which can be determined by turning the equipment off and on, the user is encouraged to try to correct the interference by one or more of the following measures:

- Reorient or relocate the receiving antenna.
- Increase the separation between the equipment and receiver.
- Connect the equipment into an outlet on a circuit different from that to which the receiver is connected.
- Consult the dealer or an experienced radio/TV technician for help.

Changes or modifications not expressly approved by the party responsible for compliance could void the user's authority to operate the equipment.

Aircraft

RF Exposure Information

This equipment complies with RF radiation exposure limits set forth for an uncontrolled environment. This equipment should be operated with minimum distance 20cm between the radiator and your body.

Remote Controller

FCC Specific Absorption Rate (SAR) information

SAR tests are conducted using standard operating positions accepted by the FCC with the device transmitting at its highest certified power level in all tested frequency bands, although the SAR is determined at the highest certified power level, the actual SAR level of the device while operating can be well below the maximum value, in general, the closer you are to a wireless base station antenna, the lower the power output. Before a new model device is available for sale to the public, it must be tested and certified to the FCC that it does not exceed the exposure limit established by the FCC, Tests for each device are performed in positions and locations (e.g. at the ear and worn on the body) as required by the FCC.

For limb worn operation, this device has been tested and meets the FCC RF exposure guidelines when used with an accessory designated for this product or when used with an accessory that contains no metal.

For body worn operation, this device has been tested and meets the FCC RF exposure guidelines when used with an accessory designated for this product or when used with an accessory that contains no metal and that positions the device a minimum of 10mm from the body.

ISED Specific Absorption Rate (SAR) information

SAR tests are conducted using standard operating positions accepted by the ISEDC with the device transmitting at its highest certified power level in all tested frequency bands, although the SAR is determined at the highest certified power level, the actual SAR level of the device while operating can be well below the maximum value, in general, the closer you are to a wireless base station antenna, the lower the power output.

Before a new model device is available for sale to the public, it must be tested and certified to the ISEDC that it does not exceed the exposure limit established by the ISEDC, Tests for each device are performed in positions and locations (e.g. at the ear and worn on the body) as required by the ISEDC.

For limb worn operation, this device has been tested and meets the ISEDCRF exposure guidelines when used with an accessory designated for

this product or when used with an accessory that contains no metal.

For body worn operation, this device has been tested and meets the ISEDC RF exposure guidelines when used with an accessory designated for this product or when used with an accessory that contains no metal and that positions the device a minimum of 10mm from the body.

Taux d'absorption spécifique (SAR) informations les tests SAR

sont effectués en utilisant les positions opérationnelles normalisées acceptées par la ISEDC, le dispositif étant à son niveau de puissance certifié le plus élevé dans toutes les bandes de fréquence testées. Avant qu'un nouveau modèle de dispositif ne soit disponible à la vente au public, il doit être testé et certifié à la ISEDC qu'il ne dépasse pas la limite d'exposition établie par la ISEDC, les Tests pour chaque dispositif sont effectués dans des positions et des emplacements (par exemple à l'oreille et porté sur le corps) comme l'exige la ISEDC.

Pour le fonctionnement des membres usés, cet appareil a été testé et répond aux lignes directrices d'exposition aux RF ISEDC lorsqu'il est utilisé avec un accessoire désigné pour ce produit ou lorsqu'il est utilisé avec un accessoire qui ne contient pas de métal.

Pour le fonctionnement du corps usé, cet appareil a été testé et répond aux lignes directrices d'exposition RF ISEDC lorsqu'il est utilisé avec un accessoire désigné pour ce produit ou lorsqu'il est utilisé avec un accessoire qui ne contient pas de métal et qui positionne cet appareil à au moins 10mm du corps.

EU/UK Compliance

Autel Robotics Co., Ltd.

hereby declares that this wireless device is in compliance with Directive 2014/53/EU and Radio Equipment Regulations 2017.



18th Floor, Block C1, Nanshan iPark, No. 1001 Xueyuan Avenue,
Nanshan District, Shenzhen, Guangdong, 518055, China
22522 29th Dr SE, Ste 101 Bothell, WA 98021 United States
Toll-free: (844) MY AUTEL or (844) 692-8835

www.autelrobotics.com

©2022 Autel Robotics Co., Ltd. All Rights Reserved



www.autelrobotics.com

©2022 Autel Robotics Co., Ltd. All Rights Reserved