

SP 386  
SP 426  
SP 466  
SP 526



- IT** **Motosega a catena per lavori forestali - MANUALE DI ISTRUZIONI**  
ATTENZIONE: prima di usare la macchina, leggere attentamente il presente libretto.
- BG** **Моторен верижен трион за горни работи - УПЪТВАНЕ ЗА УПОТРЕБА**  
ВНИМАНИЕ: преди да използвате машината прочетете внимателно настоящата книжка.
- BS** **Lačana motorna pila za šumarstvo - UPUTSTVO ZA UPOTREBU**  
PAŽNJA: prije nego što koristite ovu mašinu, pažljivo pročitajte priručnik s uputama.
- CS** **Řetězová motorová pila pro lesnické práce - NÁVOD K POUŽITÍ**  
UPOZORNĚNÍ: před použitím stroje si pozorně přečtěte tento návod k použití.
- DA** **Kædesav til skovarbejde - BRUGSANVISNING**  
ADVARSEL: læs instruktionsbogen omhyggeligt igennem, før du tager denne maskine i brug.
- DE** **Kettensäge für die Forstarbeit - GEBRAUCHSANWEISUNG**  
ACHTUNG: vor inbetriebnahme des geräts die gebrauchsanleitung aufmerksam lesen.
- EL** **Αλυσοπίριο για δασικές εργασίες - ΟΔΗΓΙΕΣ ΧΡΗΣΗΣ**  
ΠΡΟΣΟΧΗ: πριν χρησιμοποιήσετε το μηχάνημα, διαβάστε προσεκτικά το παρόν εγχειρίδιο.
- EN** **Chain-saw for forest service - OPERATOR'S MANUAL**  
WARNING: read thoroughly the instruction booklet before using the machine.
- ES** **Motosierra de cadena para trabajos forestales**  
MANUAL DE INSTRUCCIONES - ATENCIÓN: antes de utilizar la máquina, leer atentamente el presente manual.
- ET** **Kettsaag metsatöödeks - KASUTUSJUHEND**  
TÄHELEPANU: enne masina kasutamist lugeda tähelepanelikult antud kasutusjuhendit.
- FI** **Mootorisaha metsänhoitoon - KÄYTTÖOHJEET**  
VAROITUS: lue käyttöopas huolellisesti ennen koneen käyttöä.
- FR** **Scie à chaîne pour travaux forestiers - MANUEL D'UTILISATION**  
ATTENTION: lire attentivement le manuel avant d'utiliser cette machine.
- HR** **Motorna lačana pila za šumarstvo - PRIRUČNIK ZA UPORABU**  
POZOR: prije uporabe stroja, pažljivo pročitajte ovaj priručnik.
- HU** **Erdészeti motoros láncfűrész - HASZNÁLATI UTASÍTÁS**  
FIGYELEM! a gép használatá előtt olvassa el figyelmesen a jelen kézikönyvet.
- LT** **Grandininis pjūklas miško darbams - NAUDOJIMO INSTRUKCIJOS**  
DĖMESIO: prieš naudojant įrenginį, atidžiai perskaityti šį naudotojo vadovą.
- LV** **Ķēdes zāģis meža kopšanas darbiem- LIETOŠANAS INSTRUKCIJA**  
UZMANĪBU: pirms aparāta lietošanai rūpīgi izlasiet doto instrukciju.
- MK** **Моторна пила со синџир за работа во шума**  
УПАТСТВА ЗА УПОТРЕБА - ВНИМАНИЕ: прочитајте го внимателно ова упатство пред да ја користите машината.
- NL** **Kettingzaag voor boswerken - GEBRUIKERSHANDLEIDING**  
LET OP: vooraleer de machine te gebruiken, dient men deze handleiding aandachtig te lezen.
- NO** **Kjedesag for vanlig skogbruk - INSTRUKSJONSBOK**  
ADVARSEL: les denne bruksanvisningen nøye for du bruker maskinen.
- PL** **Pilarka łańcuchowa do prac leśnych - INSTRUKCJE OBSŁUGI**  
OSTRZEŻENIE: przed użyciem maszyny, należy uważnie przeczytać niniejszą instrukcję.
- PT** **Motosserra para trabalhos florestais - MANUAL DE INSTRUÇÕES**  
ATENÇÃO: antes de usar a máquina, leia atentamente o presente manual.
- RO** **Ferăstrău cu lanț pentru lucrări forestiere - MANUAL DE INSTRUCȚIUNI**  
ATENȚIE: înainte de a utiliza mașina, citiți cu atenție manualul de față.
- RU** **Цепная пила для лесохозяйственных работ**  
РУКОВОДСТВО ПО ЭКСПЛУАТАЦИИ - ВНИМАНИЕ: прежде чем пользоваться оборудованием, внимательно прочтите это руководство по эксплуатации.
- SK** **Reťazová motorová pila pre lesnícke práce - NÁVOD NA POUŽITIE**  
UPOZORNENIE: pred použitím stroja si pozorne prečítajte tento návod.
- SL** **Veržna žaga za gozdna dela - PRIROČNIK ZA UPORABO**  
POZOR: preden uporabite stroj, pazljivo preberite priručnik z navodili.
- SR** **Lačana motorna testera za šumarstvo - PRIRUČNIK SA UPUTSTVIMA**  
PAŽNJA: pre korišćenja mašine pažljivo pročitati ovaj priručnik.
- SV** **Kedjesåg för skogsarbete - BRUKSANVISNING**  
VARNING: läs igenom hela detta häfte innan du använder maskinen.
- TR** **Orman işleri için zincirli testere - KULLANIM KILAVUZU**  
DİKKAT: makineyi kullanmadan önce talimatlar içeren kilavuzu dikkate okuyun.



|  |           |
|--|-----------|
| ITALIANO - Istruzioni Originali .....                                  | <b>IT</b> |
| БЪЛГАРСКИ - Инструкция за експлоатация .....                           | <b>BG</b> |
| BOSANSKI - Prijevod originalnih uputa .....                            | <b>BS</b> |
| ČESKY - Překlad původního návodu k používání .....                     | <b>CS</b> |
| DANSK - Oversættelse af den originale brugsanvisning .....             | <b>DA</b> |
| DEUTSCH - Übersetzung der Originalbetriebsanleitung .....              | <b>DE</b> |
| ΕΛΛΗΝΙΚΑ - Μετάφραση των πρωτοτύπων οδηγιών .....                      | <b>EL</b> |
| ENGLISH - Translation of the original instruction .....                | <b>EN</b> |
| ESPAÑOL - Traducción del Manual Original .....                         | <b>ES</b> |
| EESTI - Algupärase kasutusjuhendi tõlge .....                          | <b>ET</b> |
| SUOMI - Alkuperäisten ohjeiden käännös .....                           | <b>FI</b> |
| FRANÇAIS - Traduction de la notice originale .....                     | <b>FR</b> |
| HRVATSKI - Prijevod originalnih uputa .....                            | <b>HR</b> |
| MAGYAR - Eredeti használati utasítás fordítása .....                   | <b>HU</b> |
| LIETUVIŠKAI - Originalių instrukcijų vertimas .....                    | <b>LT</b> |
| LATVIEŠU - Instrukciju tulkojums no oriģināl valodas .....             | <b>LV</b> |
| МАКЕДОНСКИ - Превод на оригиналните упатства .....                     | <b>MK</b> |
| NEDERLANDS - Vertaling van de oorspronkelijke gebruiksaanwijzing ..... | <b>NL</b> |
| NORSK - Oversettelse av den originale bruksanvisningen .....           | <b>NO</b> |
| POLSKI - Tłumaczenie instrukcji oryginalnej .....                      | <b>PL</b> |
| PORTUGUÊS - Tradução do manual original .....                          | <b>PT</b> |
| ROMÂN - Traducerea manualului fabricantului .....                      | <b>RO</b> |
| РУССКИЙ - Перевод оригинальных инструкций .....                        | <b>RU</b> |
| SLOVENSKY - Preklad pôvodného návodu na použitie .....                 | <b>SK</b> |
| SLOVENŠČINA - Prevod izvornih navodil .....                            | <b>SL</b> |
| SRPSKI - Prevod originalnih uputstva .....                             | <b>SR</b> |
| SVENSKA - Översättning av bruksanvisning i original .....              | <b>SV</b> |
| TÜRKÇE - Orijinal Talimatların Tercümesi .....                         | <b>TR</b> |

1

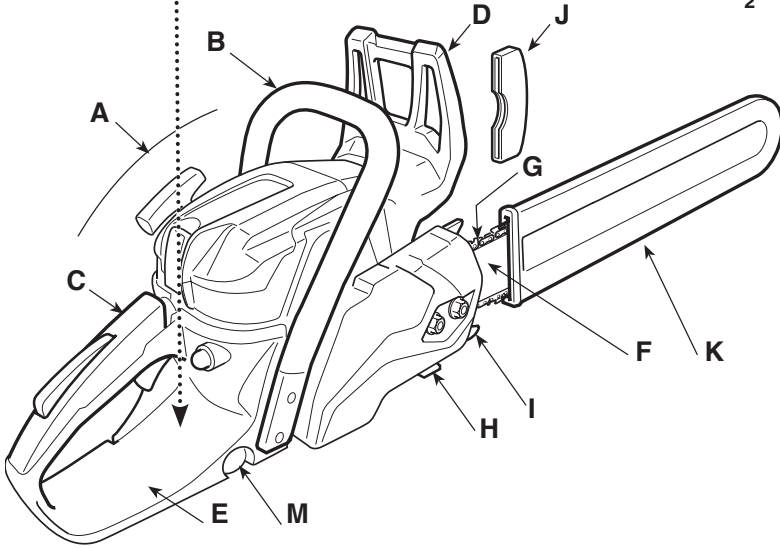
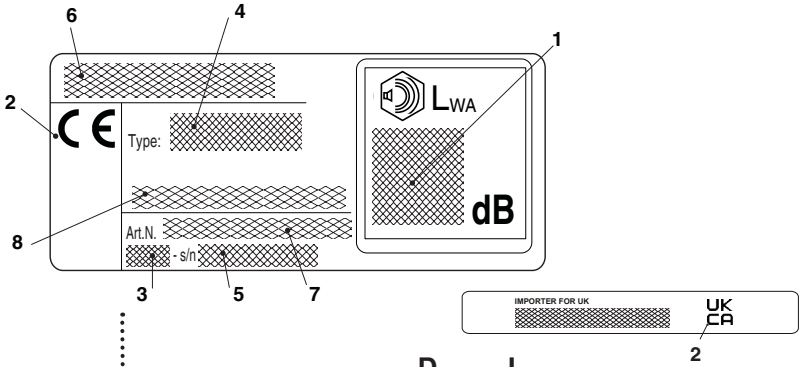

2

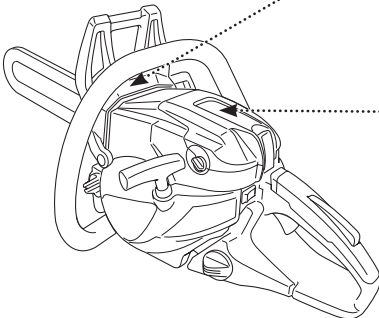

SP 386 - SP 426

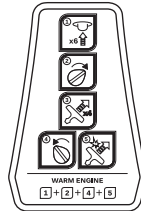

SP 466 - SP 526

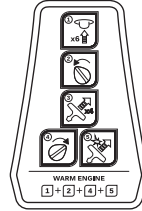

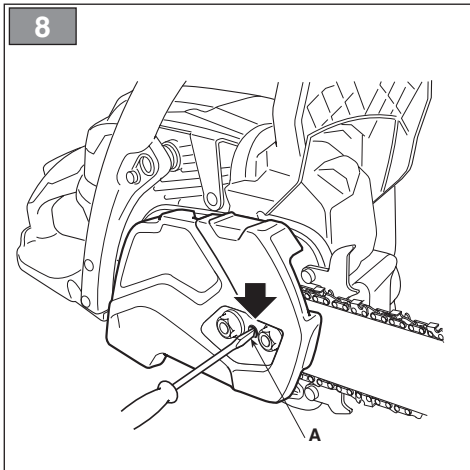
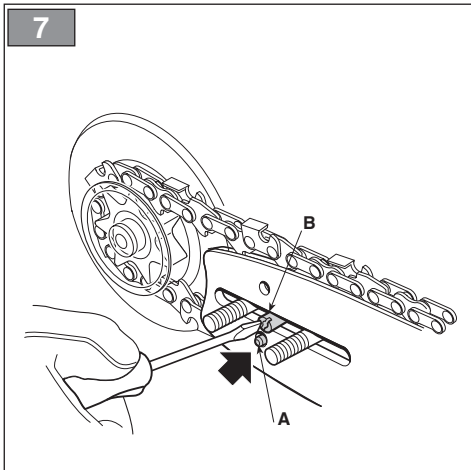
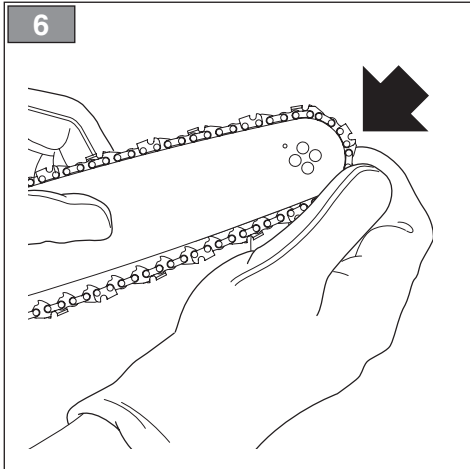
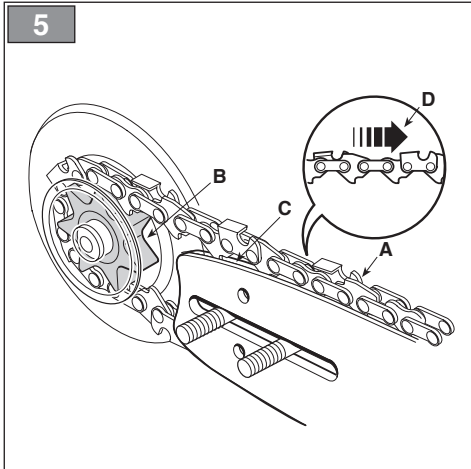
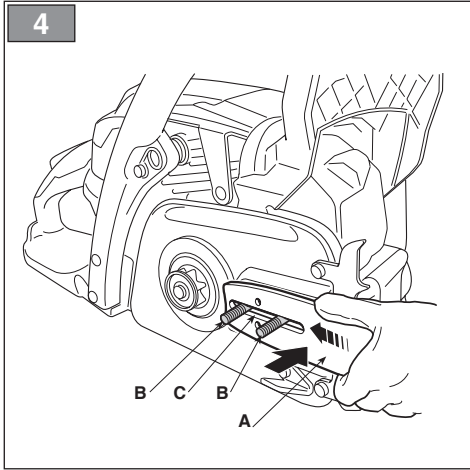
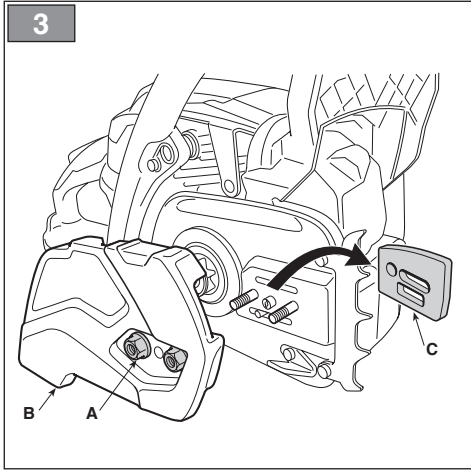

9

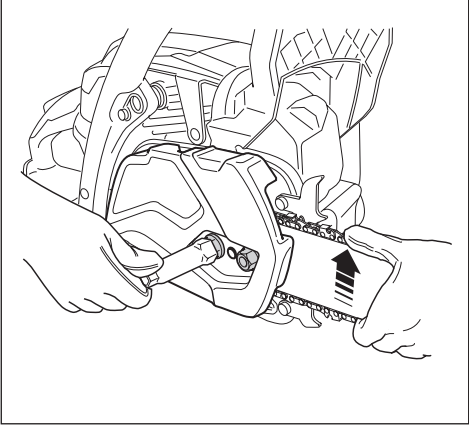

10

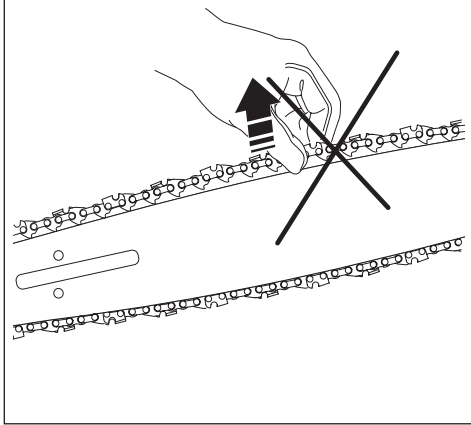

11

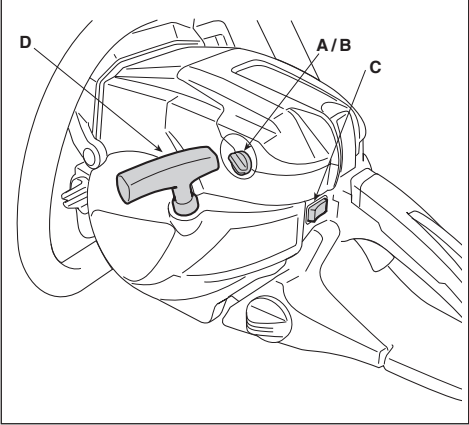

12

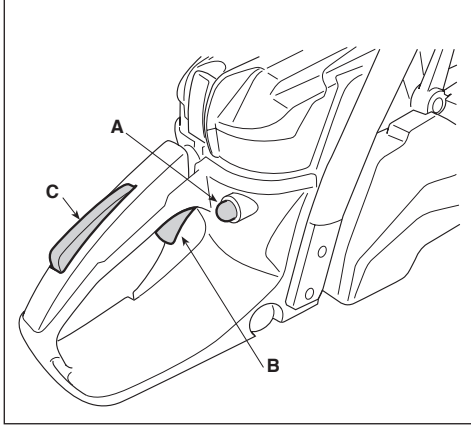

13

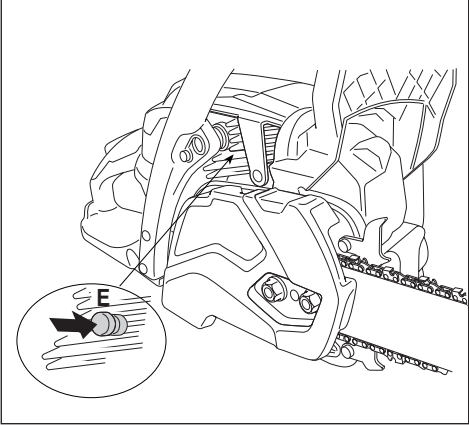

14

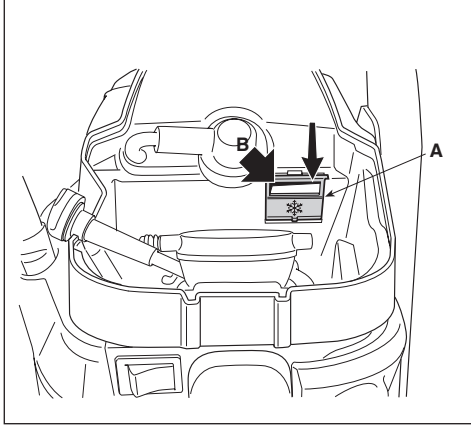

15

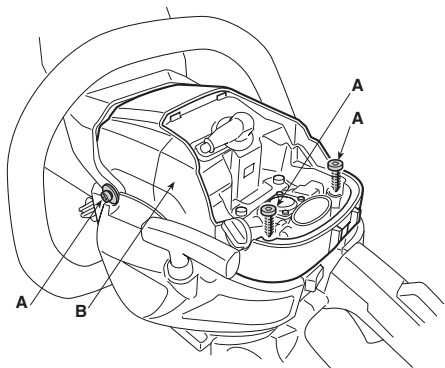

16

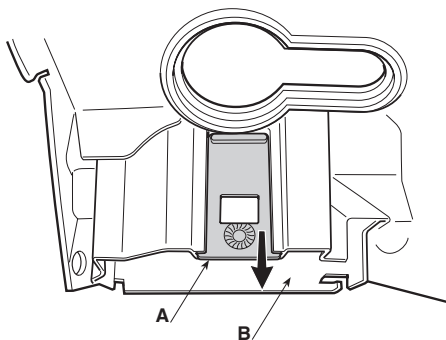

17

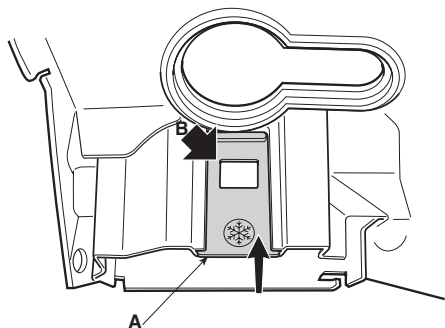

18

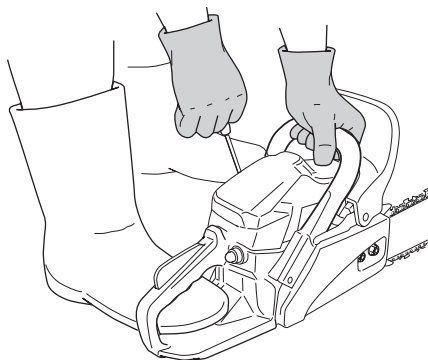

19

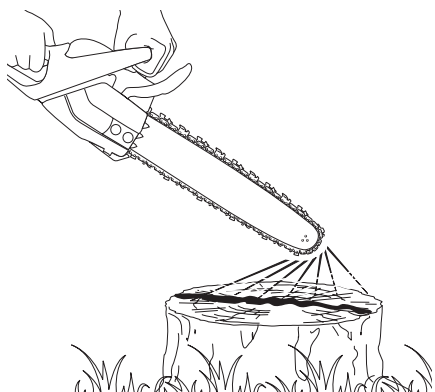

20

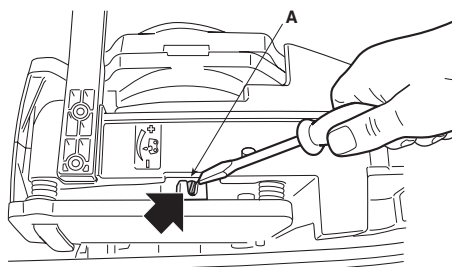

21

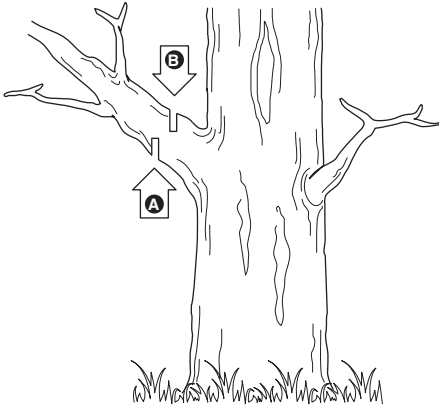

22

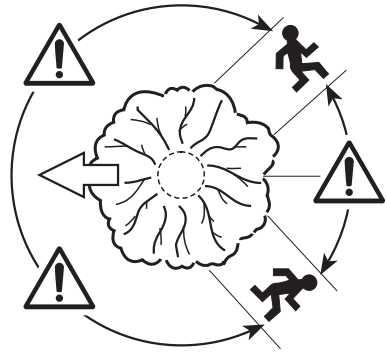

23

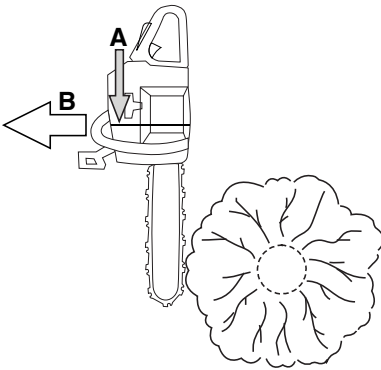

24

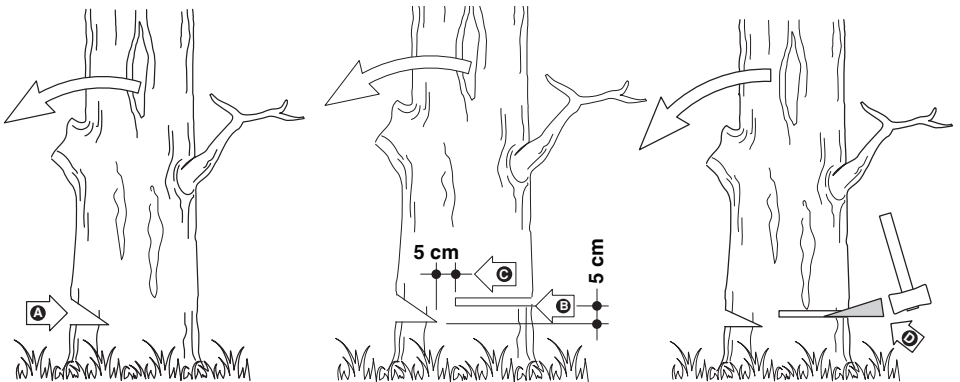



25

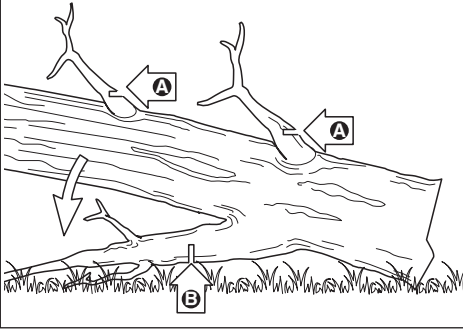

26

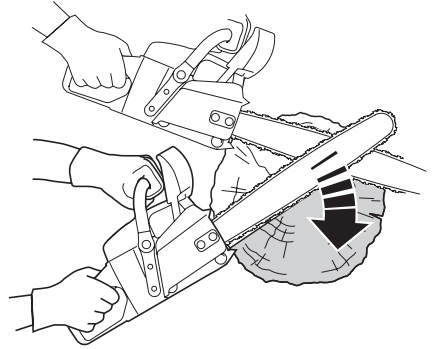

27

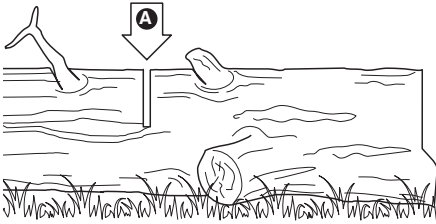

28

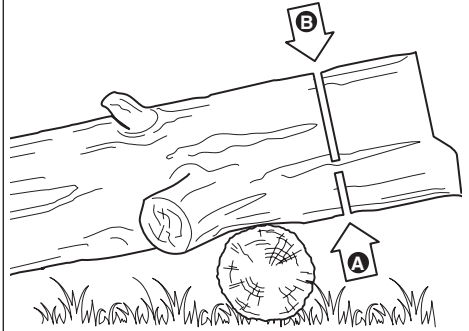

29

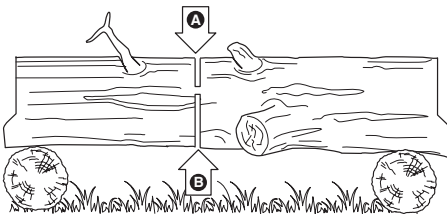

30

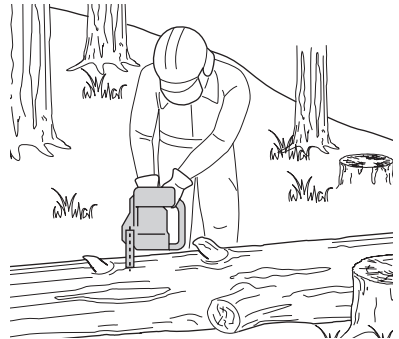

31

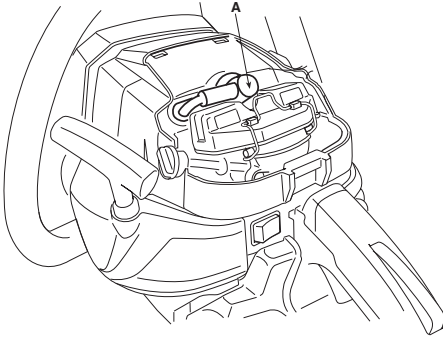

32

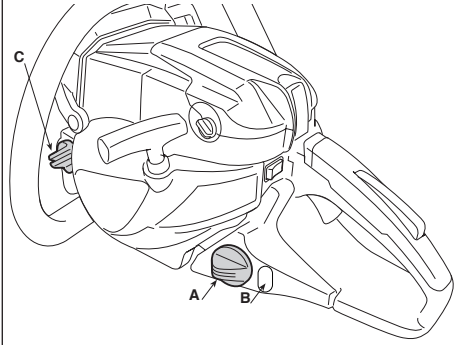

33

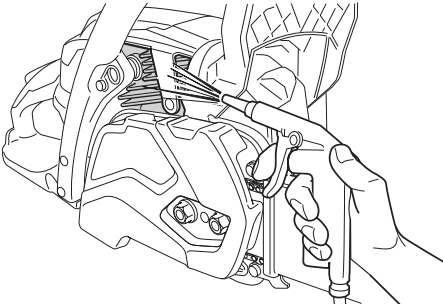

34

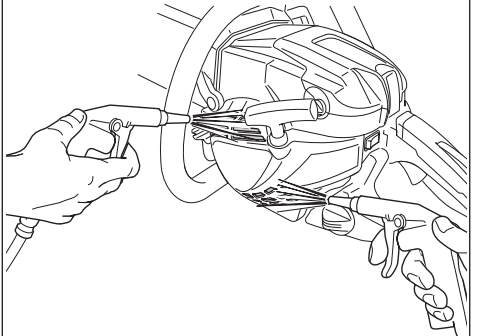

35

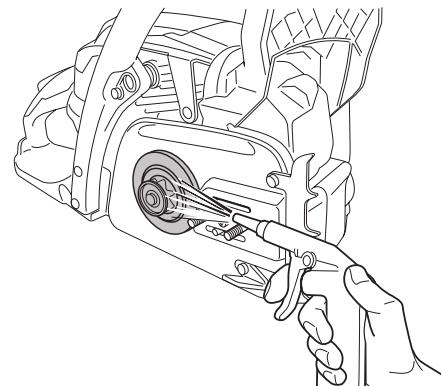

36

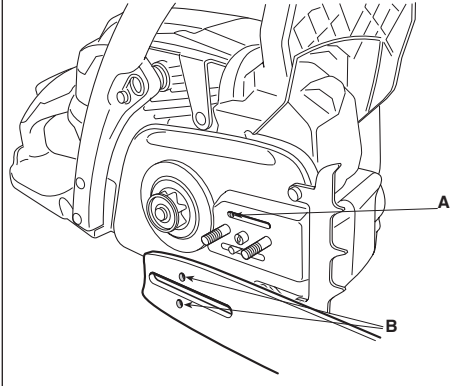

37

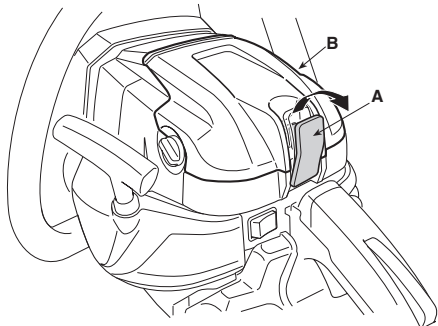

38

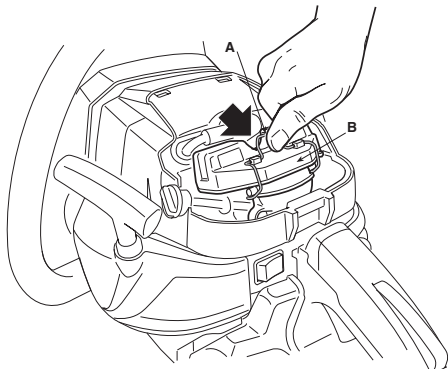

39

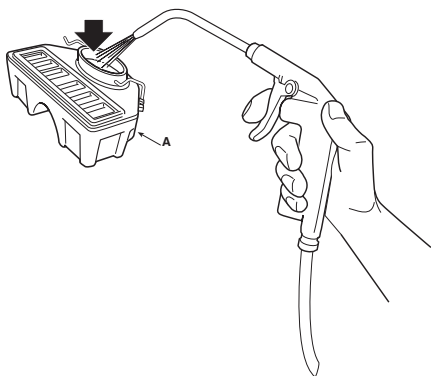

40

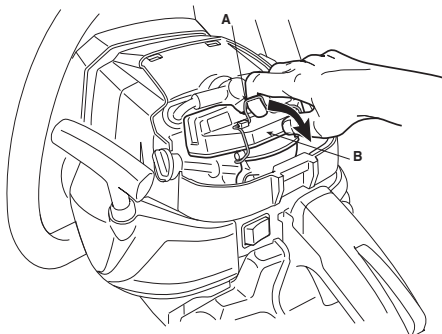

41

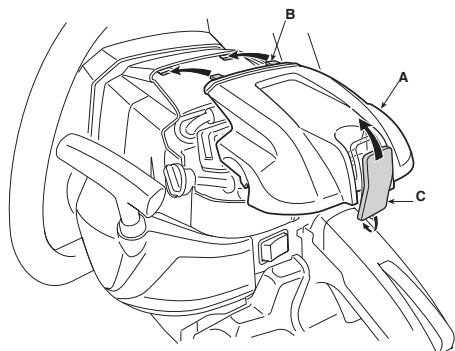

42

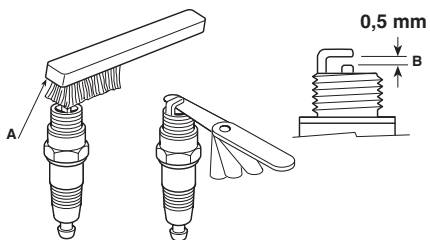

43

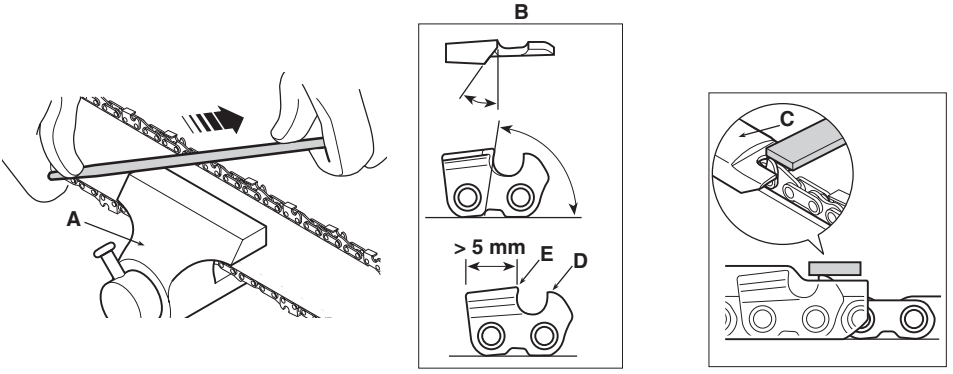

44

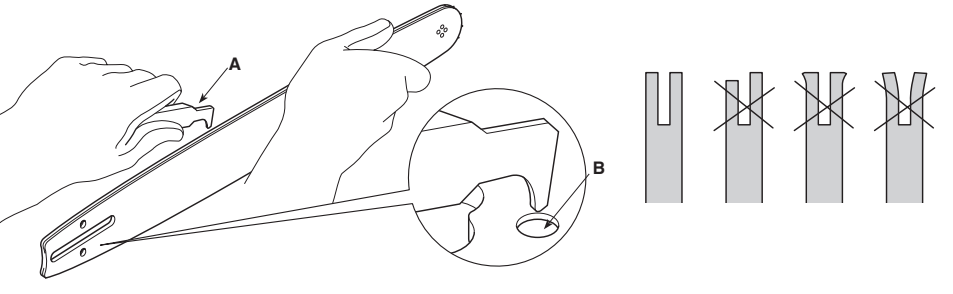

| [1]  | DATI TECNICI   |                   | SP 386                          | SP 426                                      | SP 466                                      | SP 526                                      |
|------|--|-------------------|---------------------------------|---|---|---|
| [2]  | Motore   |                   | [3] Monocilindrico<br>2 tempi   | [3] Monocilindrico<br>2 tempi               | [3] Monocilindrico<br>2 tempi               | [3] Monocilindrico<br>2 tempi               |
| [4]  | Cilindrata   | cm <sup>3</sup>   | 38,5                            | 42,4  | 46,5  | 52  |
| [5]  | Potenza  | kW                | 1,6                             | 1,9   | 2,0   | 2,3   |
| [6]  | Numero di giri al minimo   | min <sup>-1</sup> | 3000 ± 300                      | 3000 ± 300                                  | 3000 ± 300                                  | 3000 ± 300                                  |
| [7]  | Numero di giri massimo ammissibile senza carico con catena montata                           | min <sup>-1</sup> | 12000                           | 12000                                       | 12000                                       | 12000                                       |
| [8]  | Capacità del serbatoio carburante  | cm <sup>3</sup>   | 510                             | 510   | 470   | 470   |
| [9]  | Capacità del serbatoio dell'olio   | cm <sup>3</sup>   | 260                             | 260   | 260   | 260   |
| [10] | Consumo specifico alla massima potenza   | g/<br>kWh         | 560                             | 520   | 560   | 560   |
| [11] | Miscela (Benzina : Olio 2 tempi)   |                   | 40 : 1 = 2,5%                   | 40 : 1 = 2,5%                               | 40 : 1 = 2,5%                               | 40 : 1 = 2,5%                               |
| [12] | Lunghezza di taglio  | cm                | 33 cm - 14"<br>37 cm - 16"      | 30 cm - 13"<br>36,5 cm - 15"<br>38 cm - 16" | 35,5 cm - 15"<br>37 cm - 16"<br>42 cm - 18" | 35,5 cm - 15"<br>42 cm - 18"<br>47 cm - 20" |
| [13] | Spessore catena  | mm                | 0,050" / 1,27 mm                | 0,050" / 1,27 mm                            | 0,058" / 1,47 mm                            | 0,058" / 1,47 mm                            |
| [14] | Denti / passo del pignone catena   |                   | 6 / 0,375"                      | 7 / 0,325"                                  | 7 / 0,325"                                  | 7 / 0,325"                                  |
| [15] | Velocità massima della catena  | m/s               | 22,86                           | 23.114 (0,325")                             | 23,114                                      | 23,114                                      |
| [16] | Candela  |                   | CHAMPION RCJ7Y /<br>BOSCH L8RTF | CHAMPION RCJ7Y /<br>BOSCH L8RTF             | CHAMPION RCJ7Y /<br>BOSCH L8RTF             | CHAMPION RCJ7Y /<br>BOSCH L8RTF             |
| [17] | Peso (con serbatoio vuoto, senza barra e catena)   | kg                | 4,9                             | 4,9   | 5,3   | 5,3   |
| [18] | Dimensioni   |                   |                                 |   |   |   |
| [19] | Lunghezza  | mm                | 415                             | 415   | 430   | 430   |
| [20] | Larghezza  | mm                | 255                             | 255   | 230   | 230   |
| [21] | Altezza  | mm                | 290                             | 290   | 290   | 290   |
| [22] | Livello di pressione sonora (in base alla ISO 22868:2011)                                    | dB(A)             | 99,6                            | 98,7  | 99,6  | 100,6                                       |
| [23] | Incertezza di misura   | dB(A)             | 3                               | 3   | 3   | 3   |
| [24] | Livello di potenza sonora misurato (in base alla ISO 22868:2011)                             | dB(A)             | 111,5                           | 110,3                                       | 111,7                                       | 110,8                                       |
| [23] | Incertezza di misura   | dB(A)             | 3                               | 3   | 3   | 3   |
| [25] | Livello di potenza sonora garantito  | dB(A)             | 115                             | 114   | 115   | 114   |
| [26] | Vibrazioni trasmesse alla mano sull'impugnatura anteriore (in base alla ISO 22867:2011) (*)  | m/s <sup>2</sup>  | 5,72                            | 5,93  | 4,85  | 6,04  |
| [23] | Incertezza di misura   | m/s <sup>2</sup>  | 1,5                             | 1,5   | 1,5   | 1,5   |
| [27] | Vibrazioni trasmesse alla mano sull'impugnatura posteriore (in base alla ISO 22867:2011) (*) | m/s <sup>2</sup>  | 4,37                            | 5,40  | 4,86  | 6,49  |
| [23] | Incertezza di misura   | m/s <sup>2</sup>  | 1,5                             | 1,5   | 1,5   | 1,5   |
| [28] | <b>OPZIONI</b>   |                   |                                 |   |   |   |
| [29] | Dispositivo anti-gelo  |                   | ✓                               | ✓   | ✓   | ✓   |
| [30] | Valvola di decompressione  |                   | -                               | -   | -   | ✓   |

**(\*) ATTENZIONE! Il valore delle vibrazioni può variare in funzione dell'utilizzo della macchina e del suo allestimento ed essere superiore a quello indicato. È necessario stabilire le misure di sicurezza a protezione dell'utilizzatore che devono basarsi sulla stima del carico generato dalle vibrazioni nelle condizioni reali di utilizzo. A tale proposito devono essere prese in considerazione tutte le fasi del ciclo di funzionamento quali ad esempio, lo spegnimento o il funzionamento a vuoto.**

[32] TABELLA PER LA CORRETTA COMBINAZIONE DI BARRA E CATENA (Cap. 16)

| [33]<br>PASSO   | [34] BARRA                         |   |                       | [35]<br>CATENA      | [36] MODELLO |        |        |        |
|-----------------|------------------------------------|---|-----------------------|---------------------|--------------|--------|--------|--------|
| [37]<br>Pollici | [38]<br>Lunghezza:<br>Pollici / cm | [39]<br>Larghezza<br>scanalatura:<br>Pollici / mm | [40]<br>Codice        | [40]<br>Codice      | SP 386       | SP 426 | SP 466 | SP 526 |
| 3/8"            | 14" / 35 cm                        | 0,050" / 1,3                                      | OREGON<br>140SDEA041  | OREGON<br>91PX053X  | ✓            | -      | -      | -      |
| 3/8"            | 16" / 40 cm                        | 0,050" / 1,3                                      | OREGON<br>160SDEA041) | OREGON<br>91PX057X  | ✓            | -      | -      | -      |
| .325"           | 13" / 33 cm                        | 0,050" / 1,3                                      | OREGON<br>130MLBK041  | OREGON<br>95TXL056X | -            | ✓      | -      | -      |
| .325"           | 15" / 38 cm                        | 0,050" / 1,3                                      | OREGON<br>150MLBK041  | OREGON<br>95TXL064X | -            | ✓      | -      | -      |
| .325"           | 16" / 40 cm                        | 0,050" / 1,3                                      | OREGON<br>160MLBK041  | OREGON<br>95TXL066X | -            | ✓      | -      | -      |
| .325"           | 16" / 40 cm                        | 0,050" / 1,3                                      | OREGON<br>160MLBK041  | OREGON<br>95VPX066X | -            | ✓      | -      | -      |
| .325"           | 15" / 38 cm                        | 0,058" / 1,5                                      | OREGON<br>158PXBK095  | OREGON<br>21BPX064X | -            | -      | ✓      | ✓      |
| .325"           | 16" / 40 cm                        | 0,058" / 1,5                                      | OREGON<br>168PXBK095  | OREGON<br>21BPX066X | -            | -      | ✓      | -      |
| .325"           | 18" / 45 cm                        | 0,058" / 1,5                                      | OREGON<br>188PXBK095  | OREGON<br>21BPX072X | -            | -      | ✓      | ✓      |
| .325"           | 20" / 50 cm                        | 0,058" / 1,5                                      | OREGON<br>208PXBK095  | OREGON<br>21BPX078X | -            | -      | -      | ✓      |

|   |   |  |
|---|---|--|
| <p>[1] <b>BG - ТЕХНИЧЕСКИ ДАННИ</b></p> <p>[2] Двигател</p> <p>[3] Едноцилиндров двутактов</p> <p>[4] Обем на цилиндъра</p> <p>[5] Мощност</p> <p>[6] Брой обороти минимум</p> <p>[7] Брой максимално допустими обороти без натоварване при монтирана верига</p> <p>[8] Вместимост на горивния резервоар</p> <p>[9] Вместимост на масления резервоар</p> <p>[10] Специфичен разход при максимална мощност</p> <p>[11] Смес (Бензин : Масло двутактов)</p> <p>[12] Дължина на сръзване</p> <p>[13] Дебелина веригата</p> <p>[14] Зъбци / стъпка на пиньона на предавателна верига</p> <p>[15] Максимална скорост на веригата</p> <p>[16] Свещ</p> <p>[17] Тегло (с празен резервоар, без шина, верига)</p> <p>[18] Размери</p> <p>[19] Дължина</p> <p>[20] Ширина</p> <p>[21] Височина</p> <p>[22] Ниво на звуковото налягане (съгласно ISO 22868:2011)</p> <p>[23] Несигурност на измерване</p> <p>[24] Ниво на измерената звукова мощност (съгласно ISO 22868:2011)</p> <p>[25] Гарантирано ниво на звукова мощност</p> <p>[26] Вибрации, предадени на ръката върху предна дръжка (съгласно ISO 22867:2011)</p> <p>[27] Вибрации, предадени на ръката върху задна дръжка (съгласно ISO 22867:2011)</p> <p>[28] ОПЦИИ</p> <p>[29] Устройство против замръзване</p> <p>[30] Демонпресиращ клапан</p> <p>[32] ТАБЛИЦА ЗА ПРАВИЛНА КОМБИНАЦИЯ ОТ ШИНА И ВЕРИГА (Гл. 16)</p>                              | <p>[33] Стъпка</p> <p>[34] Шина</p> <p>[35] Верига</p> <p>[36] Модел</p> <p>[37] Инчове</p> <p>[38] Дължина: Инчове / см</p> <p>[39] Широчина жлеб: Инчове / мм</p> <p>[40] Код</p> <p>(*) <b>ВНИМАНИЕ!</b> Стойността на вибрациите може да варира в зависимост от използването на машината и нейното оборудване и може да бъде по-голяма от тази посочената. Необходимо е да се определи мерките за безопасност целящи защита на потребителя, които трябва да се базират върху оценка на създадено се натоварване от вибрациите, при условия на реално използване. За тази цел, трябва да се имат предвид всички фази на цикъла на работа, като например, изключването или работа на празен ход.</p> <p>[1] <b>BS - TEHNIČKI PODACI</b></p> <p>[2] Motor</p> <p>[3] Jednocilindrični dvotaktni</p> <p>[4] Kubikaža</p> <p>[5] Snaga</p> <p>[6] Broj obrtaja pri minimalnoj brzini</p> <p>[7] Maksimalni dozvoljeni broj obrtaja bez opterećenja s namontiranim lancem</p> <p>[8] Kapacitet rezervoara za gorivo</p> <p>[9] Kapacitet rezervoara za ulje</p> <p>[10] Specifična potrošnja pri maksimalnoj snazi</p> <p>[11] Smjesa goriva (Benzin : Ulje 2-taktni)</p> <p>[12] Dužina sečenja</p> <p>[13] Debljina lanca</p> <p>[14] Zubi / korak zupčanika lanca</p> <p>[15] Maksimalna brzina lanca</p> <p>[16] Svjecica</p> | <p>[17] Težina (sa praznim rezervoarom, bez vodilica lanca, lanac)</p> <p>[18] Dimenzije</p> <p>[19] Dužina</p> <p>[20] Širina</p> <p>[21] Visina</p> <p>[22] Razina zvučnog pritiska (na osnovu standarda ISO 22868:2011)</p> <p>[23] Merna nesigurnost</p> <p>[24] Izmjerena razina zvučne snage (na osnovu standarda ISO 22868:2011)</p> <p>[25] Garantirana razina zvučne snage</p> <p>[26] Vibracije koje se prenose na ruku na prednjem rukohvatu (na osnovu standarda ISO 22867:2011)</p> <p>[27] Vibracije koje se prenose na ruku na zadnjem rukohvatu (na osnovu standarda ISO 22867:2011)</p> <p>[28] OPCIJE</p> <p>[29] Uredaj za zaštitu od smrzavanja</p> <p>[30] Dekompresijski ventil</p> <p>[32] <b>TABLICA ZA ISPRAVNO KOMBINIRANJE VODILICA I LANCA (Pogl. 16)</b></p> <p>[33] <b>KORAK</b></p> <p>[34] <b>VODILICA LANCA</b></p> <p>[35] <b>LANAC</b></p> <p>[36] <b>MODEL</b></p> <p>[37] <b>Inč</b></p> <p>[38] <b>Dužina: Inč / cm</b></p> <p>[39] <b>Širina žljeba: Inč / mm</b></p> <p>[40] <b>Sifra</b></p> <p>(*) <b>PAŽNJA!</b> Vrednost vibracija može varirati u zavisnosti od upotrebe mašine i njene opreme i može biti veća od navedene. Neophodno je utvrditi sigurnosne mere za zaštitu rukovodaca koje se moraju zasnovati na proceni opterećenja koje stvaraju vibracije u realnim uslovima upotrebe. U tu svrhu treba uzeti u obzir sve faze ciklusa rada, kao što su, na primer, gašenje ili rad na prazno.</p> |
| <p>[1] <b>CS - TECHNICKÉ PARAMETRY</b></p> <p>[2] Motor</p> <p>[3] Jednoválcový dvoutaktní</p> <p>[4] Zdvihový objem</p> <p>[5] Výkon</p> <p>[6] Minimální otáčky</p> <p>[7] Maximální přípustné otáčky bez zátěže s namontovaným řetězem</p> <p>[8] Kapacita palivové nádržky</p> <p>[9] Kapacita olejové nádržky</p> <p>[10] Specifická spotřeba při maximálním výkonu</p> <p>[11] Směs (Benzin: olej pro dvoutaktní motory)</p> <p>[12] Délka řezání</p> <p>[13] Pouška řetězu</p> <p>[14] Zuby / krok pastorku řetězu</p> <p>[15] Maximální rychlost řetězu</p> <p>[16] Zapalovací svíčka</p> <p>[17] Hmotnost (s prázdnou nádržkou, bez vodičů lišta, řetěz)</p> <p>[18] Rozměry</p> <p>[19] Délka</p> <p>[20] Šířka</p> <p>[21] Výška</p> <p>[22] Úroveň akustického tlaku (dle ISO 22868:2011)</p> <p>[23] Nepřesnost měření</p> <p>[24] Naměřená hladina akustického výkonu (dle ISO 22868:2011)</p> <p>[25] Zaručená úroveň akustického výkonu</p> <p>[26] Vibrace přenášené na ruku na přední rukojeti (dle ISO 22867:2011)</p> <p>[27] Vibrace přenášené na ruku na zadní rukojeti (dle ISO 22867:2011)</p> <p>[28] MOZNOSTI</p> <p>[29] Zařízení na ochranu proti zamrznutí</p> <p>[30] Dekompresní ventil</p> <p>[32] <b>TABULKA PRO URČENÍ SPRÁVNÉ KOMBINACE VODIČÍ LIŠTY A ŘETĚZU (kap. 16)</b></p> <p>[33] <b>ROZTEC</b></p> <p>[34] <b>VODIČÍ LIŠTA</b></p> <p>[35] <b>ŘETEZ</b></p> | <p>[36] <b>MODEL</b></p> <p>[37] <b>Palce</b></p> <p>[38] <b>Délka: Palce / cm</b></p> <p>[39] <b>Šířka drážky: Palce / mm</b></p> <p>[40] <b>Kód</b></p> <p>(*) <b>UPOZORNĚNÍ!</b> Hodnota vibrací se může měnit v závislosti na použití stroje a jeho výbavy a může být vyšší než uvedená hodnota. Je třeba určit bezpečnostní a ochranná opatření uživatele, která musí vycházet z odhadu zátěže produkované vibracemi v reálných podmínkách použití. Za tímto účelem je třeba vzít v úvahu všechny fáze cyklu činnosti, jako například vypnutí a činnost naprázdno.</p> <p>[1] <b>DA - TEKNISKE DATA</b></p> <p>[2] Motor</p> <p>[3] Encylindret, 2 takts</p> <p>[4] Slagvolumen</p> <p>[5] Effekt</p> <p>[6] Omdrejningstal i minimum</p> <p>[7] Max. omdrejningstal tilladt uden belastning med monteret kæde</p> <p>[8] Brændstoftankens kapacitet</p> <p>[9] Olie tankens kapacitet</p> <p>[10] Specifikt forbrug ved max. effekt</p> <p>[11] Blanding (Benzin: 2-taktsolie)</p> <p>[12] Klippelængde</p> <p>[13] Tyk kæde</p> <p>[14] Antal tænder/dejing på kædehjul</p> <p>[15] Maksimal hastighed kæde</p> <p>[16] Tændror</p> <p>[17] Vægt (med tom tank, uden sværd, kæde)</p> <p>[18] Mål</p> <p>[19] Længde</p> <p>[20] Bredde</p>  | <p>[21] Højde</p> <p>[22] Lydtryksniveau (i henhold til ISO 22868:2011)</p> <p>[23] Usikkerhed ved målingen</p> <p>[24] Målt lyd effekt niveau (i henhold til ISO 22868:2011)</p> <p>[25] Garanteret lyd effekt niveau</p> <p>[26] Vibrationer overført til hånden på forreste håndtag (i henhold til ISO 22867:2011)</p> <p>[27] Vibrationer overført til hånden på bagerste håndtag (i henhold til ISO 22867:2011)</p> <p>[28] <b>EKSTRAUDSTYR</b></p> <p>[29] Frostbeskyttelsesanordning</p> <p>[30] Dekomprimeringsventil</p> <p>[32] <b>TABEL TIL KORREKT KOMBINATION AF SVÆRD OG KÆDE (Kap. 16)</b></p> <p>[33] <b>MELLEMRUM</b></p> <p>[34] <b>SVÆRD</b></p> <p>[35] <b>KÆDE</b></p> <p>[36] <b>MODEL</b></p> <p>[37] <b>Tommer</b></p> <p>[38] <b>Længde: Tommer / cm</b></p> <p>[39] <b>Sporbredde: Tommer / mm</b></p> <p>[40] <b>Kode</b></p> <p>(*) <b>ADVARSEL!</b> Vibrationsniveauet kan ændre sig afhængigt af brugen af maskinen og dens udstyr, og niveauet kan være højere end det oplyste. Det er nødvendigt at fastlægge sikkerhedsforanstaltningerne til beskyttelse af brugeren. De skal være baseret på et skøn af belastningen som følge af vibrationerne ved den konkrete brug. I denne forbindelse er det nødvendigt at tage højde for alle funktionscyklussens faser; eksempelvis slukning eller funktion uden produkt.</p>  |

|  |  |   |
|--|--|---|
| <p>[1] <b>DE - TECHNISCHE DATEN</b></p> <p>[2] Motor</p> <p>[3] Einzylindrisch 2-Takt</p> <p>[4] Hubraum</p> <p>[5] Leistung</p> <p>[6] Leerlaufdrehzahl</p> <p>[7] Zulässige maximale Drehzahl ohne Belastung mit montierter Kette inhalt des Kraftstofftanks</p> <p>[8] Inhalt Öltank</p> <p>[9] Spezifischer Verbrauch bei maximaler Leistung</p> <p>[10] Gemisch (Benzin: Zweitaktöl)</p> <p>[11] Schnittlänge</p> <p>[12] Dicke der Kette</p> <p>[13] Zähne / Teilung des Kettenrads</p> <p>[14] Höchstgeschwindigkeit Kette</p> <p>[15] Zündkerze</p> <p>[16] Gewicht (mit leerem Tank, ohne Schwert, Kette)</p> <p>[17] Abmessungen</p> <p>[18] Länge</p> <p>[19] Breite</p> <p>[20] Höhe</p> <p>[21] Schalldruckpegel (gemäß ISO 22868:2011)</p> <p>[22] Messungengenauigkeit</p> <p>[23] Gemessener Schalleistungspegel (gemäß ISO 22868:2011)</p> <p>[24] Garantiierter Schalleistungspegel</p> <p>[25] Zulässige auf die Hand am vorderen Handgriff übertragene Vibrationen (gemäß ISO 22867:2011)</p> <p>[26] Zulässige auf die Hand am hinteren Handgriff übertragene Vibrationen (gemäß ISO 22867:2011)</p> <p>[27] OPTIONEN</p> <p>[28] Frostschutzvorrichtung</p> <p>[29] Dekompressionsventil</p> <p>[30]</p> <p>[32] <b>TABELLE FÜR DIE KORREKTE KOMBINATION VON SCHWERT UND KETTE</b> (Kap. 16)</p> <p>[33] <b>GLIEDLÄNGE</b></p> <p>[34] <b>SCHWERT</b></p> <p>[35] <b>KETTE</b></p> <p>[36] <b>MODELLE</b></p>      | <p>[37] Zoll</p> <p>[38] Länge: Zoll / cm</p> <p>[39] Nutbreite: Zoll / mm</p> <p>[40] Code</p> <p>(*) <b>ACHTUNG!</b> Der Schwingungswert kann sich abhängig vom Einsatz und Einsatzwerkzeugen ändern und auch über dem angegebenen Wert liegen. Es besteht die Notwendigkeit, Sicherheitsmaßnahmen zum Schutz des Bedieners festzulegen, die auf einer Abschätzung der Belastung durch Schwingungen während der tatsächlichen Benutzungsbedingungen beruhen (hierbei sind alle Anteile des Betriebszyklus zu berücksichtigen, beispielsweise Zeiten, in denen das Elektrowerkzeug abgeschaltet ist, und solche, in denen es zwar eingeschaltet ist, aber ohne Belastung läuft).</p> <p>[1] <b>EL - ΤΕΧΝΙΚΑ ΧΑΡΑΚΤΗΡΙΣΤΙΚΑ</b></p> <p>[2] Κινητήρας</p> <p>[3] Μονοκύλινδρος 2 χρόνων</p> <p>[4] Κυβισμός</p> <p>[5] Ισχύς</p> <p>[6] Ελάχιστος αριθμός περιτροφιών</p> <p>[7] Μέγιστος επιτρεπόμενος αριθμός χωρίς φορτίο με την αλυσίδα συναρμολογημένη</p> <p>[8] Χωρητικότητα του ντεπόζιτου καυσίμου</p> <p>[9] Χωρητικότητα του δοχείου λαδιού</p> <p>[10] Είδος κατανάλωση στην μέγιστη ισχύ</p> <p>[11] Μέγιστο (Βενζίνη): λάδι για δίχρονους κινητήρες</p> <p>[12] Μήκος κοπής</p> <p>[13] Πάχος της αλυσίδας</p> <p>[14] Δόντια / βήμα του πινιόν αλυσίδας</p> <p>[15] Μέγιστη ταχύτητα αλυσίδας</p> <p>[16] Μπουζί</p> <p>[17] Βάρος (με το ντεπόζιτο άδειο, χωρίς λάμα, αλυσίδα)</p> <p>[18] Διαστάσεις</p> <p>[19] Μήκος</p> <p>[20] Πλάτος</p> <p>[21] Ύψος</p> | <p>[22] Στάθμη ηχητικής πίεσης (με βάση το πρότυπο ISO 22868:2011)</p> <p>[23] Αβεβαιότητα μέτρησης</p> <p>[24] Μετρημένη στάθμη ηχητικής ισχύος (με βάση το πρότυπο ISO 22868:2011)</p> <p>[25] Στάθμη εγγυώμενης ηχητικής ισχύος</p> <p>[26] Κραδασμοί στο χέρι στην εμπρός χειρολαβή (με βάση το πρότυπο ISO 22867:2011)</p> <p>[27] Κραδασμοί στο χέρι στην πίσω χειρολαβή (με βάση το πρότυπο ISO 22867:2011)</p> <p>[28] ΠΡΟΑΙΡΕΤΙΚΑ</p> <p>[29] Σύστημα αντιπαγετικής προστασίας</p> <p>[30] Βαλβίδα αποσυμπίεσης</p> <p>[32] <b>ΠΙΝΑΚΑΣ ΓΙΑ ΤΟ ΣΩΣΤΟ ΣΥΝΔΥΑΣΜΟ ΜΠΑΡΑΣ ΚΑΙ ΑΛΥΣΙΔΑΣ</b> (Κεφ. 16)</p> <p>[33] ΒΉΜΑ</p> <p>[34] ΛΑΜΑ</p> <p>[35] ΑΛΥΣΙΔΑ</p> <p>[36] ΜΟΝΤ ΕΛΟ</p> <p>[37] Ίντσες</p> <p>[38] Μήκος: Ίντσες / cm</p> <p>[39] Εγκοπή: Ίντσες / mm</p> <p>[40] Κωδικός</p> <p>(*) <b>ΠΡΟΣΟΧΗ!</b> Η τιμή των δονήσεων μπορεί να μεταβάλλεται σε σχέση με την χρήση της μηχανής και της χρήσης του εξοπλισμού και να είναι μεγαλύτερη από την υποδεικνυόμενη. Είναι αναγκαίος ο καθορισμός των μέτρων ασφαλείας και προστασίας του χρήστη που θα πρέπει να βασίζονται στον υπολογισμό του φορτίου που παράγεται από τις δονήσεις στις πραγματικές συνθήκες χρήσης. Για αυτό το σκοπό θα πρέπει να λαμβάνονται υπόψη όλες οι φάσεις του κύκλου λειτουργίας όπως για παράδειγμα, η απενεργοποίηση ή η χρήση σε κενό.</p>        |
| <p>[1] <b>EN - TECHNICAL DATA</b></p> <p>[2] Engine</p> <p>[3] 2-stroke single cylinder</p> <p>[4] Displacement</p> <p>[5] Power</p> <p>[6] Idle RPM</p> <p>[7] Maximum admissible rpm without load with chain installed</p> <p>[8] Fuel tank capacity</p> <p>[9] Oil tank capacity</p> <p>[10] Maximum power specific consumption</p> <p>[11] Fuel mixture (Petrol: 2-stroke oil)</p> <p>[12] Cutting length</p> <p>[13] Chain gauge</p> <p>[14] Chain pinion teeth / pitch</p> <p>[15] Maximum chain speed</p> <p>[16] Spark plug</p> <p>[17] Weight (with empty tank, without bar, chain)</p> <p>[18] Dimensions</p> <p>[19] Length</p> <p>[20] Width</p> <p>[21] Height</p> <p>[22] Sound pressure level (according to ISO 22868:2011 &amp; BS EN ISO 22868:2011)</p> <p>[23] Measurement uncertainty</p> <p>[24] Measured sound power level (according to ISO 22868:2011 &amp; BS EN ISO 22868:2011)</p> <p>[25] Guaranteed sound power level</p> <p>[26] Vibrations transmitted to hand on front handle (according to ISO 22867:2011 &amp; BS EN ISO 22868:2011)</p> <p>[27] Vibrations transmitted to hand on rear handle (according to ISO 22867:2011 &amp; BS EN ISO 22868:2011)</p> <p>[28] <b>OPTIONS</b></p> <p>[29] Anti-freeze device</p> <p>[30] Pressure relief valve</p> <p>[32] <b>CORRECT BAR AND CHAIN COMBINATION TABLE</b> (Chap. 16)</p> <p>[33] <b>PITCH</b></p> <p>[34] <b>BAR</b></p> <p>[35] <b>CHAIN</b></p> | <p>[36] <b>MODEL</b></p> <p>[37] Inches</p> <p>[38] Length: Inches / cm</p> <p>[39] Groove width: Inches / mm</p> <p>[40] Code</p> <p>(*) <b>WARNING!</b> The vibration value may vary according to the usage of the machine and its fitted equipment, and be higher than the one indicated. Safety measures must be established to protect the user and must be based on the load estimate generated by the vibrations in real usage conditions. In this regard, all the operational cycle phases must be taken into consideration, such as switching off or idle running.</p> <p>[1] <b>ES - DATOS TÉCNICOS</b></p> <p>[2] Motor</p> <p>[3] Monocilíndrico 2 tiempos</p> <p>[4] Cilíndrada</p> <p>[5] Potencia</p> <p>[6] Número de revoluciones por mínimo</p> <p>[7] Número de revoluciones máximo admisible sin carga con cadena montada</p> <p>[8] Capacidad del depósito carburante</p> <p>[9] Capacidad del depósito del aceite</p> <p>[10] Consumo específico a la máxima potencia</p> <p>[11] Mezcla (Gasolina: Aceite 2 Tiempos)</p> <p>[12] Longitud de corte</p> <p>[13] Espesor de la cadena</p> <p>[14] Dientes / paso del piñón cadena</p> <p>[15] Velocidad máxima de la cadena</p> <p>[16] Bujía</p> <p>[17] Peso (con depósito vacío, sin barra, cadena)</p> <p>[18] Dimensiones</p> <p>[19] Longitud</p> <p>[20] Anchura</p>   | <p>[21] Altura</p> <p>[22] Nivel de presión sonora (según ISO 22868:2011)</p> <p>[23] Incertidumbre de medida</p> <p>[24] Nivel de potencia sonora medido (según ISO 22868:2011)</p> <p>[25] Nivel de potencia sonora garantizado</p> <p>[26] Vibraciones transmitidas a la mano en la empuñadura anterior (según ISO 22867:2011)</p> <p>[27] Vibraciones transmitidas a la mano en la empuñadura posterior (según ISO 22867:2011)</p> <p>[28] <b>OPCIONES</b></p> <p>[29] Dispositivo anti-hielo</p> <p>[30] Válvula de descompresión</p> <p>[32] <b>TABLA PARA LA CORRECTA COMBINACIÓN DE BARRA Y CADENA</b> (Cap. 16)</p> <p>[33] <b>PASO</b></p> <p>[34] <b>BARRA</b></p> <p>[35] <b>CADENA</b></p> <p>[36] <b>MODELO</b></p> <p>[37] Pulgadas</p> <p>[38] Longitud: Pulgadas / cm</p> <p>[39] Anchura ranura: Pulgadas / mm</p> <p>[40] Código</p> <p>(*) <b>¡ATENCIÓN!</b> El valor de las vibraciones puede variar según el uso de la máquina y de su montaje y ser superior al indicado. Se aconseja establecer las medidas de seguridad de protección del usuario que deben descender estimando la carga generada por las vibraciones en las condiciones reales de uso. Para dicha finalidad deben tomarse en consideración todas las fases del ciclo de funcionamiento como por ejemplo, el apagado o el funcionamiento en vacío.</p> |



|   |  |   |
|---|--|---|
| <p>[1] <b>ET - TEHNILISED ANDMED</b></p> <p>[2] Mootor</p> <p>[3] Uhe silindriga 2-taktiline</p> <p>[4] Tõomaht</p> <p>[5] Võimsus</p> <p>[6] Pöörete arv tühkikäigul</p> <p>[7] Maksimumpöörete lubatud arv ilma pingeta monteeritud ketiga</p> <p>[8] Kütusepaagi maht</p> <p>[9] Olipaagi maht</p> <p>[10] Eritarbiimine maksimumvõimsusel</p> <p>[11] Segu (bensiin: õli 2 taktiline)</p> <p>[12] Lõikepikkus</p> <p>[13] Keti paksus</p> <p>[14] Keti hammarratta hambad / samm</p> <p>[15] Maksimaalne kiirus kett</p> <p>[16] Kүүлal</p> <p>[17] Kaal (tühja paagiga, ilma saelatt, kett)</p> <p>[18] Mootmed</p> <p>[19] Pikkus</p> <p>[20] Laius</p> <p>[21] Kõrgus</p> <p>[22] Helirõhu tase (vastavalt ISO 22868:2011)</p> <p>[23] Mõitmisebaätäpsus</p> <p>[24] Helivõimsuse mõõdetav tase (vastavalt ISO 22868:2011)</p> <p>[25] Garanteeritud helivõimsuse tase</p> <p>[26] Eesmiselt käepidemelt käele üle kanduv vibratsioon (vastavalt ISO 22867:2011)</p> <p>[27] Tagumiselt käepidemelt käele üle kanduv vibratsioon (vastavalt ISO 22867:2011)</p> <p>[28] VALIKUD</p> <p>[29] Jäätumisvastane seade</p> <p>[30] Kaitseklaapp</p> <p>[32] SAEKETI JA -PLAADI KOMBINATSIOONIDE TABEL (16. ptk)</p> <p>[33] SÄMM</p> <p>[34] SÄELÄTT</p> <p>[35] KETT</p> <p>[36] MUDELIL</p> <p>[37] Tõlli</p>   | <p>[38] Pikkus: Tõlli / cm</p> <p>[39] Kanali Laius: Tõlli / mm</p> <p>[40] Kood</p> <p>(*) TÄHELEPANU! Vibratsioonitase võib varieeruda vastavalt masina kasutusele ja tema ettevalmistusele ja olla näidatud suurem. Vajalik on määrata kasutajast lähtuvad ohutusmäärad, mis peavad baseeruma tegelikes kasutustingimustes vibratsiooni poolt tekitatud laetuse hindamisel. Sellel eesmärgil tuleb arvestada kõiki töotsukli lõike, nagu näiteks väljalülitamine või töötamine tühkikäigul.</p> <p>[1] <b>FI - TEKNISET TIEDOT</b></p> <p>[2] Moottori</p> <p>[3] Yksisynterinen 2-vaiheinen</p> <p>[4] Tilavuus</p> <p>[5] Teho</p> <p>[6] Kierroslukumäärä minimissä</p> <p>[7] Salituu suurin mahdollinen kierroslukumäärä ilman kuormaa ketju asennettuna</p> <p>[8] Polttoainesäiliön tilavuus</p> <p>[9] Öljysäiliön tilavuus</p> <p>[10] Omaniskulutus täystehoilla</p> <p>[11] Polttoainesos (Bensiini: Öljy 2-tahti)</p> <p>[12] Leikkauksen pituus</p> <p>[13] Ketjun paksuus</p> <p>[14] Ketjun hammarrataan hampaat / hammasluku</p> <p>[15] Maksiminopeus ketju</p> <p>[16] Sytytystulppa</p> <p>[17] Paino (säiliö tyhjänä, ilman terälevy, ketju)</p> <p>[18] Koko</p> <p>[19] Pituus</p> <p>[20] Leveys</p> <p>[21] Korkeus</p> <p>[22] Äänenpaineen taso (ISO 22868:2011:n mukaisesti)</p> <p>[23] Epätarkka mittaus</p> <p>[24] Mitattu äänitehotaso (ISO 22868:2011:n mukaisesti)</p>  | <p>[25] Taattu äänitehotaso</p> <p>[26] Etukahvaan kohdistuva tärinä (ISO 22867:2011:n mukaisesti)</p> <p>[27] Takakahvaan kohdistuva tärinä (ISO 22867:2011:n mukaisesti)</p> <p>[28] VALINNAT</p> <p>[29] Jäätymisenestolaite</p> <p>[30] Paineenallennusventtiili</p> <p>[32] TÄULUKKO TERÄLEVYN JA KETJUN OIKEA YHDISTELMÄ (Luku 16)</p> <p>[33] KULLKU</p> <p>[34] TERÄLEVY</p> <p>[35] KETJU</p> <p>[36] MALLI</p> <p>[37] Tuumaa</p> <p>[38] Pituus: Tuumaa / cm</p> <p>[39] Uran Leveys: Tuumaa / mm</p> <p>[40] Koodi</p> <p>(*) HUOMAUTUS! Tärinäarvo voi vaihdella laitteen käyttötoiminnon mukaan ja laitteen kokoonpanon mukaan ja arvo voi olla korkeampi kuin annettu arvo. Käyttäjän turvallisuuden takaamiseksi on ryhdyttävä tarvittaviin varoitoimenpiteisiin, jotka määritellään todellisisä käytössä arvioidun tärinäkuormituksen pohjalta. Tämän vuoksi on huomioitava kaikki toimintasyklin vaiheet kuten esim. laitteen sammuttaminen tai laiteen tyhjäkäynti.</p>  |
| <p>[1] <b>FR - CARACTÉRISTIQUES TECHNIQUES</b></p> <p>[2] Moteur</p> <p>[3] Monocylindrique à 2 temps</p> <p>[4] Cylindrée</p> <p>[5] Puissance</p> <p>[6] Nombre de tours au minimum</p> <p>[7] Nombre de tours maximum admissible sans charge avec la chaîne montée</p> <p>[8] Capacité du réservoir de carburant</p> <p>[9] Capacité du réservoir de l'huile</p> <p>[10] Consommation spécifique à la puissance maximum</p> <p>[11] Mélange (Essence : Huile 2 temps)</p> <p>[12] Longueur de coupe</p> <p>[13] Epaisseur de la chaîne</p> <p>[14] Dents / pas du pignon de chaîne</p> <p>[15] Vitesse maximale de la chaîne</p> <p>[16] Bougie</p> <p>[17] Poids (avec le réservoir vide, sans guide-chaîne, chaîne)</p> <p>[18] Dimensions</p> <p>[19] Longueur</p> <p>[20] Largeur</p> <p>[21] Hauteur</p> <p>[22] Niveau de pression sonore (selon la norme ISO 22868:2011)</p> <p>[23] Incertitude de la mesure</p> <p>[24] Niveau de puissance sonore mesuré (selon la norme ISO 22868:2011)</p> <p>[25] Niveau de puissance sonore garanti</p> <p>[26] Vibrations transmises à la main sur la poignée antérieure</p> <p>[27] Vibrations transmises à la main sur la poignée postérieure (selon la norme ISO 22867:2011)</p> <p>[28] OPTIONS</p> <p>[29] Dispositif antigel</p> <p>[30] Valve de décompression</p> <p>[32] TABLEAU DES COMBINAISONS CORRECTES ENTRE GUIDE-CHAÎNE ET CHAÎNE (Chap. 16)</p> <p>[33] PAS</p> <p>[34] GUIDE-CHAÎNE</p> | <p>[35] CHAÎNE</p> <p>[36] MODÈLE</p> <p>[37] Pouces</p> <p>[38] Longueur: Pouces / cm</p> <p>[39] Largeur Rainure: Pouces / mm</p> <p>[40] Code</p> <p>(*) ATTENTION! La valeur des vibrations peut varier en fonction de l'emploi de la machine et de son agencement, et peut devenir supérieure à la valeur qui est indiquée. Il est nécessaire d'établir les mesures de sécurité pour la protection de l'utilisateur; ces dernières doivent être fondées sur l'estimation de la charge engendrée par les vibrations dans les conditions réelles d'utilisation. A ce sujet, il faut prendre en considération toutes les phases du cycle de fonctionnement, comme par exemple l'extinction ou le fonctionnement à vide.</p> <p>[1] <b>HR - TEHNIČKI PODACI</b></p> <p>[2] Motor</p> <p>[3] Jednocilindrični, 2-taktni</p> <p>[4] Radni obujam</p> <p>[5] Snaga</p> <p>[6] Broj okretaja na minimumu</p> <p>[7] Najviši dopušteni broj okretaja bez opterećenja, s montiranim lancem</p> <p>[8] Zapremina spremnika goriva</p> <p>[9] Zapremina spremnika ulja</p> <p>[10] Specifična potrošnja pri maksimalnoj snazi</p> <p>[11] Mješavina (benzin: ulje za 2-taktni motore)</p> <p>[12] Dužina rezanja</p> <p>[13] Debljina lanca</p> <p>[14] Zupci / korak lančanika</p> <p>[15] Maksimalna brzina lanca</p> <p>[16] Svječica</p> <p>[17] Težina (s praznim spremnikom, bez vodilica, lanac)</p> <p>[18] Dimenzije</p> <p>[19] Dužina</p> <p>[20] Širina</p> | <p>[21] Visina</p> <p>[22] Razina zvučnog tlaka (na osnovu standarda ISO 22868:2011)</p> <p>[23] Mjerna nesigurnost</p> <p>[24] Izmjerena razina zvučne snage (na osnovu standarda ISO 22868:2011)</p> <p>[25] Zajamčena razina zvučne snage</p> <p>[26] Vibracije koje se prenose na ruku putem prednje ručke (na osnovu standarda ISO 22867:2011)</p> <p>[27] Vibracije koje se prenose na ruku putem stražnje ručke (na osnovu standarda ISO 22867:2011)</p> <p>[28] OPCJE</p> <p>[29] Uređaj protiv zaledivanja</p> <p>[30] Ventil za dekompresiju</p> <p>[32] TABLICA ZA PRAVILNO KOMBINIRANJE VODILICE I LANCA (16. pog.)</p> <p>[33] KORAK</p> <p>[34] VODILICA</p> <p>[35] LANAC</p> <p>[36] MODEL</p> <p>[37] Inč</p> <p>[38] Dužina: Inč / cm</p> <p>[39] Širina Uzljebljenja: Inč / mm</p> <p>[40] Šifra</p> <p>(*) POZOR! Ovisno o korištenju stroja i njegove opreme, vrijednost vibracija može biti drugačija te biti i viša od one naznačene. Potrebno je utvrditi sigurnosne mjere radi zaštite korisnika, na temelju procjene opterećenja kojeg stvaraju vibracije u stvarnim uvjetima korištenja. U vezi s tim treba uzeti u obzir sve faze radnog ciklusa, kao na primjer isključivanje ili rad na prazno.</p> |

|  |   |  |
|--|---|--|
| <p>[1] <b>HU - MŰSZAKI ADATOK</b></p> <p>[2] Motor</p> <p>[3] Egyhengeres, kétütemű</p> <p>[4] Hengerűrtartalom</p> <p>[5] Teljesítmény</p> <p>[6] Fordulatszám alapjáraton</p> <p>[7] Maximális megengedett fordulatszám terhelés nélkül, felszerelt lánccal</p> <p>[8] Uzemanyagtartály kapacitása</p> <p>[9] Olajtartály kapacitása</p> <p>[10] Fajlagos fogyasztás a legnagyobb teljesítményen</p> <p>[11] Keverék (Benzin: Olaj kétütemű motorokhoz)</p> <p>[12] Vágáshossz</p> <p>[13] Vastag lánccal</p> <p>[14] Lánccal fogaskerék fogai / fogosztása</p> <p>[15] Maximális sebesség lánccal</p> <p>[16] Gyertya</p> <p>[17] Súly (üres tartállyal, anélkül vezetőlemez, lánccal)</p> <p>[18] Méretek</p> <p>[19] Hosszúság</p> <p>[20] Szélesség</p> <p>[21] Magasság</p> <p>[22] Hangnyomásszint (ISO 22868:2011 szabvány alapján)</p> <p>[23] Mérésbizonytalanság</p> <p>[24] Mért zajteljesítmény szint (ISO 22868:2011 szabvány alapján)</p> <p>[25] Garantált zajteljesítmény szint</p> <p>[26] Az elülős markolatnál a kéz felé továbbított rezgések (ISO 22867:2011 szabvány alapján)</p> <p>[27] A hátsó markolatnál a kéz felé továbbított rezgések (ISO 22867:2011 szabvány alapján)</p> <p>[28] OPCIÓK</p> <p>[29] Fagyvédelmi szerkezet</p> <p>[30] Nyomáscsökkentő szelep</p> <p>[32] <b>HELYES VEZETŐLEMEZ/LÁNC KOMBINÁCIÓK TÁBLAZATA (16. fejelet)</b></p> <p>[33] <b>LÁNCOSZTÁS</b></p> <p>[34] <b>VEZETŐLEMEZ</b></p>      | <p>[35] LÁNC</p> <p>[36] MODEL</p> <p>[37] Hüvelyk</p> <p>[38] Hossz: Hüvelyk / cm</p> <p>[39] Vájat Szélesség: Hüvelyk / mm</p> <p>[40] Kód</p> <p>(*) FIGYELEM! A vibrációérték változhat a gép alkalmazási funkciója és felszereltsége függvényében, és meghaladhatja a megadott értéket. Meg kell határozni a felhasználó védelmét szolgáló biztonsági intézkedéseket, melyeket a valós használati feltételek melletti vibrációs terhelések becsülésére kell alapozni. Ebből a célból figyelembe kell venni az üzemi ciklus összes fázisát, például a kikapcsolást és az üresben való üzemelést is.</p> <p>[1] <b>LT - TECHINIAI DUOMENYS</b></p> <p>[2] Variklis</p> <p>[3] Mono cilindrinis 2 fazių</p> <p>[4] Variklio tūris</p> <p>[5] Galia</p> <p>[6] Apsisukimų numeris minimaliu režimu</p> <p>[7] Maksimaliai priimtinas apsisukimų numeris be arovimo su sumontuota grandine</p> <p>[8] Degalų bako talpa</p> <p>[9] Alyvos bakelio pajėgumas yra</p> <p>[10] Maksimalaus galinġumo specifinis suauodojimas</p> <p>[11] Mišinys (Benzinas: alyva 2 taktu)</p> <p>[12] Pjovimo ilgis</p> <p>[13] Storis grandinės</p> <p>[14] Dantys / grandinės dantratuکو žingsnis</p> <p>[15] Maksimalus greitis grandinės</p> <p>[16] Žvakė</p> <p>[17] Svoris (tuščiu bakeliu, be strypas, grandinė)</p> <p>[18] Įsmatavimai</p> <p>[19] Ilgis</p> <p>[20] Plotis</p> | <p>[21] Aukštis</p> <p>[22] Garso slėgio lygis (pagal „ISO 22868:2011“)</p> <p>[23] Matavimo netikslumas</p> <p>[24] Įsmatuotas garso galios pagala „ISO 22868:2011“)</p> <p>[25] Garantuotas garso galios lygis</p> <p>[26] Vibracijos lygis, priekinė rankena pagal „ISO 22867:2011“)</p> <p>[27] Vibracijos lygis, galinė rankena pagal „ISO 22867:2011“)</p> <p>[28] PASIRENKAMI PRIEDAI</p> <p>[29] Apsauga nuo užšalimo</p> <p>[30] Dekompresijos vožtuvas</p> <p>[32] <b>TAISYKLINGO JUOSTOS IR GRANDINĖS SUDERINIMO LENTELE (16 skyri.)</b></p> <p>[33] ZINGSNIS</p> <p>[34] STRYPAS</p> <p>[35] GRANDINĖ</p> <p>[36] MODELIS</p> <p>[37] Colis</p> <p>[38] Ilgis: Colis / cm</p> <p>[39] Griovelio Plotis: Colis / mm</p> <p>[40] Kodas</p> <p>(*) <b>DĖMESIO!</b> Vibracijų vertę gali keistis atsižvelgiant į įrenginio darbo pobūdį ir jo paruošimą ir gali viršyti nurodytas vertes. Būtina nustatyti saugumo matavimams, kurie turi remtis sugeneruotais vibracijų apktovos apskaičiavimais realiomis naudojimo sąlygomis. Dėl šios priežasties turi būti atsižvelgiama į visas veikimo ciklo fazes, kaip pavyzdžiui, išjungimas arba veikimas tuščiai.</p>  |
| <p>[1] <b>LV - TEHNISKIE DATI</b></p> <p>[2] Dzinējs</p> <p>[3] Viencilindra, divtaktu</p> <p>[4] Cilindru tilpums</p> <p>[5] Jauda</p> <p>[6] Aprēzniešu skaits minimālajā režimā</p> <p>[7] Maksimālais pielaujamais aprēzniešu skaits bez slodzes ar uzšādītu ķēdi</p> <p>[8] Degvielas tvētnes tilpums</p> <p>[9] Eļļas tvētnes tilpums</p> <p>[10] Ipatnējais patēriņš pie maksimālās jaudas</p> <p>[11] Maisījums (benzīns : eļļa 2-taktu dzinējiem)</p> <p>[12] Griešanas garums</p> <p>[13] Kēdes biežums</p> <p>[14] Kēdes zobrata zobi / solis</p> <p>[15] Maksimālais ātrums kēdes</p> <p>[16] Svece</p> <p>[17] Svārs (ar tukšu tvērtni, bez sliede, ķēde)</p> <p>[18] Izмери</p> <p>[19] Garums</p> <p>[20] Platums</p> <p>[21] Augstums</p> <p>[22] Skaņas spiediena līmenis (Saskaņā ar ISO 22868:2011 prasībām)</p> <p>[23] Mērijuma kļūda</p> <p>[24] Mērītās skaņas jaudas līmenis (Saskaņā ar ISO 22868:2011 prasībām)</p> <p>[25] Garantētās skaņas jaudas līmenis</p> <p>[26] No priekšējā roktura rokai nododamā vibrācija (Saskaņā ar ISO 22867:2011 prasībām)</p> <p>[27] No aizmugurējā roktura rokai nododamā vibrācija (Saskaņā ar ISO 22867:2011 prasībām)</p> <p>[28] <b>PAPILDĀPRIKĀJUMS</b></p> <p>[29] Pretaizsaišanas ierīce</p> <p>[30] Dekompresijas vārst</p> <p>[32] <b>SLIEZU UN KĒZU PAREIZU KOMBINĀCIJU TABULA (16. nod.)</b></p> <p>[33] <b>SOLIS</b></p> <p>[34] <b>SLIEDE</b></p> <p>[35] <b>KĒDE</b></p> | <p>[36] MODELIM</p> <p>[37] Collas</p> <p>[38] Garums: Collas / cm</p> <p>[39] Rievas Platums: Collas / mm</p> <p>[40] Kods</p> <p>(*) <b>UZMANĪBU!</b> Vibrāciju vērtība ir atkarīga no mašīnas lietošanas veida un no apkopojuma, iedējādi, tā var pārsniegt norādīto vērtību. Izstrādājot drošības un mašīnas lietotāja aizsardzības noteikumus ir jāizmanto vibrāciju noslodzes novērtējums, kas veidojas reālos lietošanas apstākļos. Tādējādi, ir jāņem vērā visi darbības cikla posmi, piemēram, izslēgšana vai darbība tukšgaitā.</p> <p>[1] <b>MK - TEHNICHI PODATOICI</b></p> <p>[2] Мотор</p> <p>[3] Моноцилиндричен двотактен</p> <p>[4] Напачитет</p> <p>[5] Мокност</p> <p>[6] Број на вртежи на минимум</p> <p>[7] Број на дозволени вртежи на максимум без оптоварување со поставен ланец</p> <p>[8] Напачитет на резервоарот за гориво</p> <p>[9] Напачитет на резервоарот за масло</p> <p>[10] Специфична потрошувачка на максимална моќност</p> <p>[11] Мешавина (бензин: масло за двотактни мотори)</p> <p>[12] Должина на сечење</p> <p>[13] Дебелина на синцидрот</p> <p>[14] Запци на ланецот / степен на запченикот на ланецот</p> <p>[15] Максималната брзина на сабудување</p> <p>[16] Свеќичка</p> <p>[17] Тежина (со празен резервоар, без лост, ланец)</p> <p>[18] Димензии</p> <p>[19] Должина</p> <p>[20] Ширина</p>                     | <p>[21] Висина</p> <p>[22] Ниво на звучен притисок (според ISO 22868:2011)</p> <p>[23] Несигурност за мерење</p> <p>[24] Измерено ниво на бучава (според ISO 22868:2011)</p> <p>[25] Гарантирано ниво на бучава</p> <p>[26] Вибрации што се пренесуваат на раце од предната рачка (според ISO 22867:2011)</p> <p>[27] Вибрации што се пренесуваат на раце од задната рачка (според ISO 22867:2011)</p> <p>[28] ОПЦИИ</p> <p>[29] Уред против смрзнување</p> <p>[30] Вентил за декомпресија</p> <p>[32] <b>ТАБЕЛА ЗА ПРАВИЛНА КОМБИНАЦИЈА НА ЛОСТВО И СИНЦИРИ (поглавје 16)</b></p> <p>[33] <b>СТЕПЕН</b></p> <p>[34] <b>ЛОСТ</b></p> <p>[35] <b>ЛАНЕЦ</b></p> <p>[36] <b>МОДЕЛ</b></p> <p>[37] <b>ИНЧИ</b></p> <p>[38] <b>Должина: инчи / см</b></p> <p>[39] <b>Љлеб: инчи / мм</b></p> <p>[40] <b>КОД</b></p> <p>(*) <b>ВНИМАНИЕ!</b> Вредноста на вибрациите може да варира од функцијата на примената на машината и на нејзините поставки и е супериорна како што е посочена. Неопходно е да се воспостават мерките на безбедност и заштита за корисникот што треба да го поднесат генерираното оптоварување од вибрациите во реални услови на употреба. Танвата намбра треба да ги земе во предвид сите фази на циклусот на работа, како што се на примеро исклучувањето или работа на празно.</p> |

|   |  |  |
|---|--|--|
| <p>[1] <b>NL - TECHNISCHE GEGEVENS</b></p> <p>[2] Motor</p> <p>[3] Tweekt-ééncilindermotor</p> <p>[4] Cilinderinhoud</p> <p>[5] Vermogen</p> <p>[6] Minimaal toerental</p> <p>[7] Maximaal toegestaan toerental zonder lading met ketting gemonteerd</p> <p>[8] Vermogen brandstofreservoir</p> <p>[9] Vermogen van het oliereservoir</p> <p>[10] Specifiek gebruik bij maximaal vermogen</p> <p>[11] Mengeling (Benzine : Olie 2-takt)</p> <p>[12] Lengte van de snit</p> <p>[13] Dikte van de ketting</p> <p>[14] Tand(en) / steek van het kettingwiel</p> <p>[15] Maximum speed ketting</p> <p>[16] Bougie</p> <p>[17] Gewicht (bij leeg reservoir, zonder blad, ketting)</p> <p>[18] Afmetingen</p> <p>[19] Lengte</p> <p>[20] Breedte</p> <p>[21] Hoogte</p> <p>[22] Niveau geluidsdruk (op basis van ISO 22868:2011)</p> <p>[23] Meetonzekerheid</p> <p>[24] Gemeten geluidsvermogeniveau (op basis van ISO 22868:2011)</p> <p>[25] Gegarandeerd geluidsniveau</p> <p>[26] Trillingen overgedragen op de hand op de voorste handgreep (op basis van ISO 22867:2011)</p> <p>[27] Trillingen overgedragen op de hand op de achterste handgreep (op basis van ISO 22867:2011)</p> <p>[28] OPTIES</p> <p>[29] Antivries-irrichting</p> <p>[30] Reduceerklap</p> <p>[32] <b>TABEL VOOR DE CORRECTE COMBINATIE VAN BLAD EN KETTING</b> (Hfdstk. 16)</p> <p>[33] <b>STAP</b></p> <p>[34] <b>BLAD</b></p>   | <p>[35] KETTING</p> <p>[36] MODEL</p> <p>[37] Duimen</p> <p>[38] Lengte: Duimen / cm</p> <p>[39] Breedte Groef: Duimen / mm</p> <p>[40] Code</p> <p>(*) LET OP: De waarde van de trillingen kan variëren in functie van het gebruik van de machine en zijn uitrusting en hoger zijn dan de aangegeven waarde. De veiligheidsmaatregelen ter bescherming van de gebruiker moeten bepaald worden door zich te baseren op de schatting van de lading veroorzaakt door de trillingen onder de werkelijke gebruiksomstandigheden. Hiervoor moeten alle fases van de werkingscyclus in beschouwing genomen worden zoals bijvoorbeeld het uitzetten en de onbelastte werking.</p> <p>[1] <b>NO - TEKNISKE DATA</b></p> <p>[2] Motor</p> <p>[3] Ensyndret, totakts</p> <p>[4] Slagvolum</p> <p>[5] Ytelse</p> <p>[6] Turtall ved tomgang</p> <p>[7] Maks tillatt turtall uten belastning med montert kjede</p> <p>[8] Drivstofftankens kapasitet</p> <p>[9] Oljetankens kapasitet</p> <p>[10] Forbruk ved maks effekt</p> <p>[11] Blanding (Bensin: 2-takts olje)</p> <p>[12] Kuttelengde</p> <p>[13] Tykk kjede</p> <p>[14] Tannhulets tenner / tagger</p> <p>[15] Topplart kjede</p> <p>[16] Tennplugg</p> <p>[17] Vekt (med tom tank, uten sverd, kjede)</p> <p>[18] Mål</p> <p>[19] Lengde</p> <p>[20] Breedde</p>   | <p>[21] Høyde</p> <p>[22] Lydtrykknivå (iht. ISO 22868:2011)</p> <p>[23] Måleusikkerhet</p> <p>[24] Målt lydeffektnivå (iht. ISO 22868:2011)</p> <p>[25] Garantert lydeffektnivå</p> <p>[26] Vibrasjoner overført til hånden på det fremre håndtaket (iht. ISO 22867:2011)</p> <p>[27] Vibrasjoner overført til hånden på det bakre håndtaket (iht. ISO 22867:2011)</p> <p>[28] EKSTRAUTSTYR</p> <p>[29] Enhet for frostsikring</p> <p>[30] Dekompresjonsventil</p> <p>[32] <b>TABELL FOR RIKTIG KOMBINASJON AV SVERD OG KJEDE</b> (kap. 16)</p> <p>[33] <b>MELLOMROM</b></p> <p>[34] <b>SVERD</b></p> <p>[35] <b>KJEDE</b></p> <p>[36] <b>MODELL</b></p> <p>[37] Tommer</p> <p>[38] Lengde: Tommer / cm</p> <p>[39] Sporbredd: Tommer / mm</p> <p>[40] Kode</p> <p>(*) ADVARSEL! Vibrasjonsnivået kan variere avhengig av bruken av maskinen samt hvordan den er utstyrt, og det kan være høyere enn det angitte. Det er nødvendig å fastsette sikkerhetstiltak for beskyttelse av brukeren som må basere seg på et estimat av belastningen som skyldes vibrasjoner under reelle bruksbetingelser. I den sammenheng må en ta i betraktning samtlige faser i funksjonssyklusen, herunder for eksempel avslåing om tomgang.</p>   |
| <p>[1] <b>PL - DANE TECHNICZNE</b></p> <p>[2] Silnik</p> <p>[3] Jednocylindrowy 2-suwowy</p> <p>[4] Pojemność skokowa</p> <p>[5] Moc</p> <p>[6] Liczba obrotów na minimum</p> <p>[7] Liczba obrotów maksymalnie dopuszczalna, bez obciążenia z łańcuchem zamontowanym</p> <p>[8] Pojemność zbiornika paliwa</p> <p>[9] Pojemność zbiornika oleju</p> <p>[10] Zużycie specyficzne przy maksymalnej mocy</p> <p>[11] Mieszanka (Benzyna : Olej do silnika 2-suwowego)</p> <p>[12] Długość cięcia</p> <p>[13] Grubość łańcucha</p> <p>[14] Żęby / podziałka koła zębatego łańcucha</p> <p>[15] Maksymalna prędkość łańcucha</p> <p>[16] Świeca zapłonowa</p> <p>[17] Ciężar (z pustym zbiornikiem, bez prowadnica, łańcuch)</p> <p>[18] Wymiary</p> <p>[19] Długość</p> <p>[20] Szerokość</p> <p>[21] Wysokość</p> <p>[22] Poziom ciśnienia akustycznego (zgodnie z ISO 22868:2011)</p> <p>[23] Niepewność pomiaru</p> <p>[24] Mierzony poziom mocy akustycznej (zgodnie z ISO 22868:2011)</p> <p>[25] Gwarantowany poziom mocy akustycznej</p> <p>[26] Wibracje przekazywane na rękę poprzez uchwyty przedni (zgodnie z ISO 22867:2011)</p> <p>[27] Wibracje przekazywane na rękę poprzez uchwyty tylny (zgodnie z ISO 22867:2011)</p> <p>[28] OPCJE</p> <p>[29] Urządzenie zabezpieczające przed zamrzaniem</p> <p>[30] Zawór dekompresyjny</p> <p>[32] <b>TABELA PRAWIDŁOWEJ KOMBINACJI PRAWIDŁOWY I ŁAŃCUCHA</b> (rozd. 16)</p> <p>[33] <b>ROZSTAW</b></p> | <p>[34] <b>PROWADNICA</b></p> <p>[35] <b>ŁANCUCH</b></p> <p>[36] <b>MODELU</b></p> <p>[37] <b>Cale</b></p> <p>[38] <b>Długość: Cale / cm</b></p> <p>[39] <b>Szerokość Bruzdy: Cale / mm</b></p> <p>[40] <b>Kod</b></p> <p>(*) UWAGA! Wartość wibracji może się zmieniać w zależności od użycia urządzenia i jego wyposażenia i może być wyższa od tej wskazanej. Niezbędny jest ustalenie środków bezpieczeństwa w celu ochrony użytkownika, które muszą się opierać na oszacowaniu ładunku wytwarzanego przez wibracje w rzeczywistych warunkach użytkowania. W tym celu powinny być brane pod uwagę wszystkich fazy cyklu funkcjonowania, jak na przykład wyłączenie lub działanie na biegu jałowym.</p> <p>[1] <b>PT - DADOS TÉCNICOS</b></p> <p>[2] Motor</p> <p>[3] Monocilindro 2 tempos</p> <p>[4] Cilindrada</p> <p>[5] Potência</p> <p>[6] Número de rotações no mínimo</p> <p>[7] Número máximo permitido de rotações sem carga com corrente montada</p> <p>[8] Capacidade do tanque de combustível</p> <p>[9] Capacidade do tanque do óleo</p> <p>[10] Consumo específico na potência máxima</p> <p>[11] Mistura (Gasolina : Óleo 2 tempos)</p> <p>[12] Comprimento de corte</p> <p>[13] Spessore catena</p> <p>[14] Dentes / distância entre eixos do pínhão da corrente</p> <p>[15] Velocidade máxima da cadeia</p> <p>[16] Vela</p> <p>[17] Peso (com tanque vazio, sem lâmina-guia, corrente)</p> <p>[18] Dimensões</p> | <p>[19] Comprimento</p> <p>[20] Largura</p> <p>[21] Altura</p> <p>[22] Nivel de pressão sonora (com base na ISO 22868:2011)</p> <p>[23] Incerteza de medição</p> <p>[24] Nivel medido de potência sonora (com base na ISO 22868:2011)</p> <p>[25] Nivel garantido de potência sonora</p> <p>[26] Vibraciones transmitidas na mão sobre a pega dianteira (com base na ISO 22867:2011)</p> <p>[27] Vibraciones transmitidas na mão sobre a pega traseira (com base na ISO 22867:2011)</p> <p>[28] OPCOES</p> <p>[29] Dispositivo antigelo</p> <p>[30] Válvula de descompressão</p> <p>[32] <b>TABELA PARA A COMBINAÇÃO CORRETA DE BARRA E CORRENTE</b> (Cap. 16)</p> <p>[33] <b>PASSO</b></p> <p>[34] <b>LÂMINA-GUIA</b></p> <p>[35] <b>CORRENTE</b></p> <p>[36] <b>MODELO</b></p> <p>[37] <b>Polegadas</b></p> <p>[38] <b>Comprimento: Polegadas / cm</b></p> <p>[39] <b>Largura do canal: Polegadas / mm</b></p> <p>[40] <b>Código</b></p> <p>(*) ATENÇÃO! O valor das vibrações pode variar em função da utilização da máquina e da sua preparação e ser acima daquele indicado. É necessário estabelecer as medidas de segurança para a proteção do utilizador que devem ser baseadas na estimativa de carga gerada pelas vibrações nas condições reais de utilização. Para tal fim, devem ser levadas em consideração todas as fases do ciclo de funcionamento tais como por exemplo, o desligamento ou o funcionamento em vazio.</p> |

|   |  |  |
|---|--|--|
| <p>[1] <b>RO - DATE TEHNICE</b></p> <p>[2] Motor</p> <p>[3] Monocilindric în 2 timpi</p> <p>[4] Cilindree</p> <p>[5] Putere</p> <p>[6] Număr minim de rotații pe minut</p> <p>[7] Numărul maxim admis de rotații fără sarcină cu lanțul montat</p> <p>[8] Capacitate rezervor carburant</p> <p>[9] Capacitate rezervor ulei</p> <p>[10] Consum specific la capacitate maximă</p> <p>[11] Amestec (Benzină: Ulei pt. motoare în doi timpi)</p> <p>[12] Lungime tăiere</p> <p>[13] Grosimea lanțului</p> <p>[14] Dinți / pas pinion lanț</p> <p>[15] Maximă de viteză a lanțului</p> <p>[16] Bujie</p> <p>[17] Greutate (cu rezervorul gol, fara bară, lanț)</p> <p>[18] Dimensiuni</p> <p>[19] Lungime</p> <p>[20] Lățime</p> <p>[21] Înălțime</p> <p>[22] Nivel de presiune sonoră (în conformitate cu ISO 22868:2011)</p> <p>[23] Nesigurantă în măsurare</p> <p>[24] Nivel de putere sonoră măsurat (în conformitate cu ISO 22868:2011)</p> <p>[25] Nivel de putere sonoră garantat</p> <p>[26] Vibrații percepute de mâna operatorului, pe mânerul anterior (în conformitate cu ISO 22867:2011)</p> <p>[27] Vibrații percepute de mâna operatorului, pe mânerul posterior (în conformitate cu ISO 22867:2011)</p> <p>[28] OPTIUNI</p> <p>[29] Dispozitiv antigel</p> <p>[30] Supapă de decompresie</p> <p>[32] <b>TABELA PENTRU O ASOCIERE CORECTĂ BARĂ-LANȚ (Cap. 16)</b></p> <p>[33] PAS</p> <p>[34] BARĂ</p> <p>[35] LANȚ</p> | <p>[36] MODELUL</p> <p>[37] Toli</p> <p>[38] Lungime: Toli / cm</p> <p>[39] Lățime Canelură: Toli / mm</p> <p>[40] Cod</p> <p>(*) <b>ATENȚIE!</b> Valoarea vibrațiilor depinde de modul în care este folosită mașina și de dotările acesteia, putând să fie mai mare decât cea indicată. Stabilirea măsurilor de siguranță este necesară pentru protecția utilizatorului și trebuie să se bazeze pe estimarea sarcinii transmise prin vibrații în condiții reale de utilizare. În acest scop, trebuie luate în considerare toate fazele ciclului de funcționare, cum ar fi, de exemplu, oprirea sau proba de funcționare în gol.</p> <p>[1] <b>RU - ТЕХНИЧЕСКИЕ ХАРАКТЕРИСТИКИ</b></p> <p>[2] Двигатель</p> <p>[3] Одноцилиндровый 2-тактный</p> <p>[4] Объем</p> <p>[5] Мощность</p> <p>[6] Число оборотов в минимальном режиме</p> <p>[7] Максимальное допустимое число оборотов без нагрузки с установленной цепью</p> <p>[8] Объем топливного бака</p> <p>[9] Объем масляного бака</p> <p>[10] Удельный расход топлива при максимальной мощности</p> <p>[11] Смесь (Бензин : Масло 2 такта)</p> <p>[12] Длина резки</p> <p>[13] Толщина цепи</p> <p>[14] Зубцы / шаг звездочки цепи</p> <p>[15] Максимальная скорость цепи</p> <p>[16] Свеча</p> <p>[17] Вес (при пустом баке, без шина, цепи)</p> <p>[18] Габариты</p> <p>[19] Длина</p> <p>[20] Ширина</p> | <p>[21] Высота</p> <p>[22] Уровень звукового давления (согласно ISO 22868:2011)</p> <p>[23] Неточность размеров</p> <p>[24] Уровень измеренной звуковой мощности (согласно ISO 22868:2011)</p> <p>[25] Гарантируемый уровень звуковой мощности</p> <p>[26] Вибрация, сообщаемая руке на передней рукоятке (согласно ISO 22867:2011)</p> <p>[27] Вибрация, сообщаемая руке на задней рукоятке (согласно ISO 22867:2011)</p> <p>[28] ОПЦИИ</p> <p>[29] Система против замерзания</p> <p>[30] Декомпрессионный клапан</p> <p>[32] <b>ТАБЛИЦА ПРАВИЛЬНЫХ КОМБИНАЦИИ ШИНА-ЦЕПЬ (гл. 16)</b></p> <p>[33] ШАГ</p> <p>[34] ШИНА</p> <p>[35] ЦЕПЬ</p> <p>[36] МОДЕЛЬ</p> <p>[37] Дюймов</p> <p>[38] Длина: Дюймы / см</p> <p>[39] Ширина Канавки: Дюймы / мм</p> <p>[40] Код</p> <p>(*) <b>ВНИМАНИЕ!</b> Уровень вибрации может меняться в зависимости от применения машины и ее оснащения, и превышать указанный уровень. Необходимо установить правила техники безопасности для защиты пользователя, которые должны основываться на оценке нагрузки, сгенерированной вибрацией в фактических условиях эксплуатации. Для этого необходимо принять во внимание все этапы рабочего цикла, включая выключение и холостой ход.</p> |
| <p>[1] <b>SK - TECHNICKÉ PARAMETRE</b></p> <p>[2] Motor</p> <p>[3] Jednoválcový dvoutaktní</p> <p>[4] Zdvihový objem</p> <p>[5] Výkon</p> <p>[6] Voľnožeňotné otáčky</p> <p>[7] Maximálne prípustné otáčky bez záťaže s namontovanou reťazou</p> <p>[8] Kapacita palivovej nádrže</p> <p>[9] Kapacita olejovej nádrže</p> <p>[10] Špecifická spotreba pri maximálnom výkone</p> <p>[11] Zmes (benzín: olej pre 2-taktné motory)</p> <p>[12] Rezná dĺžka</p> <p>[13] Hrúbka reťaze</p> <p>[14] Zuby / rozstup reťazovky</p> <p>[15] Maximálna rýchlosť reťaze</p> <p>[16] Zapaľovacia sviečka</p> <p>[17] Hmotnosť (s prázdnuou nádržou, bez vodiaca lišta, reťaz)</p> <p>[18] Rozmery</p> <p>[19] Dĺžka</p> <p>[20] Šírka</p> <p>[21] Výška</p> <p>[22] Úroveň akustického tlaku (na základe ISO 22868:2011)</p> <p>[23] Nepresnosť merania</p> <p>[24] Hladina nameraného akustického výkonu (na základe ISO 22868:2011)</p> <p>[25] Zaručená úroveň akustického výkonu</p> <p>[26] Vibrácie prenášané na ruku na prednej rukoväti (na základe ISO 22867:2011)</p> <p>[27] Vibrácie prenášané na ruku na zadnej rukoväti (na základe ISO 22867:2011)</p> <p>[28] MOŽNOSTI</p> <p>[29] Zariadenie na ochranu proti zamrznutiu</p> <p>[30] Dekompresný ventil</p> <p>[32] <b>TABUĽKA PRE URČENIE SPRÁVNEJ KOMBINÁCIE VODIACEJ LIŠTY A REŤAZE (kap. 16)</b></p> <p>[33] ROZSTUP</p> <p>[34] VODIACA LIŠTA</p> <p>[35] REŤAZ</p>       | <p>[36] MODEL</p> <p>[37] Palce</p> <p>[38] Dĺžka: Palce / cm</p> <p>[39] Šírka drážky: Palce / mm</p> <p>[40] Kód</p> <p>(*) <b>UPOZORNENIE!</b> Hodnota vibrácií sa môže meniť v závislosti na použití stroja a jeho vybavy a môže byť vyššia ako je uvedené. Je potrebné určiť bezpečnostné a ochranné opatrenia užívateľa, ktoré musia vychádzať z odhadu zaťaženia vibráciami v reálnych podmienkach použitia. Pre tento účel je potrebné vziať do úvahy všetky fázy činnosti, ako napríklad vypnutie a činnosť naprázdno.</p> <p>[1] <b>SL - TEHNIČNI PODATKI</b></p> <p>[2] Motor</p> <p>[3] Encilindrski dvotaktni 2 stopnji</p> <p>[4] Gibna prostornina motorja</p> <p>[5] Moč</p> <p>[6] Število obratov na minimumu</p> <p>[7] Maksimalno dovoljeno število obratov brez obremenitve z montirano verigo</p> <p>[8] Prostornina rezervoarja za gorivo</p> <p>[9] Prostornina oljnega rezervoarja</p> <p>[10] Špecifična poraba pri največji moči</p> <p>[11] Mešanica (bencin : olje 2-taktni motor)</p> <p>[12] Dolžina reza</p> <p>[13] Debelina verige</p> <p>[14] Zobniki / hod veriznega pastorka</p> <p>[15] Največja hitrost verige</p> <p>[16] Svečka</p> <p>[17] Teža (s prazninim rezervoarjem, brez drog, veriga)</p> <p>[18] Dimenzije</p> <p>[19] Dolžina</p> <p>[20] Širina</p>   | <p>[21] Višina</p> <p>[22] Raven zvočnega pritiska (glede na ISO 22868:2011)</p> <p>[23] Nezanemljivost meritve</p> <p>[24] Raven izmerjene zvočne moči (glede na ISO 22868:2011)</p> <p>[25] Raven zagotovljene zvočne moči</p> <p>[26] Vibracije, ki se prenašajo na roko na sprednjem ročaju (glede na ISO 22867:2011)</p> <p>[27] Vibracije, ki se prenašajo na roko na zadnjem ročaju (glede na ISO 22867:2011)</p> <p>[28] OPCIJE</p> <p>[29] Naprava proti zmrzavanju</p> <p>[30] Dekompresijski ventil</p> <p>[32] <b>TABELA ZA PRAVILNO KOMBINACIJO MECA IN VERIGE (Pogl. 16)</b></p> <p>[33] KORAK</p> <p>[34] DROG</p> <p>[35] VERIGA</p> <p>[36] MODEL</p> <p>[37] Palci</p> <p>[38] Dolžina: Palci / cm</p> <p>[39] Širina Utora: Palci / mm</p> <p>[40] Šifra</p> <p>(*) <b>POZORI!</b> Vrednost vibracij lahko varira glede na uporabo stroja in na njegovo opremo in je lahko višja od označene. Treba je določiti varnostne ukrepe za zaščito uporabnika, ki morajo izhajati iz ocene obremenitve, ki jo povzročajo vibracije v realnih pogojih delovanja. V ta namen je treba upoštevati vse faze ciklusa delovanja kot so na primer izklop ali delovanje v mrtvem domu.</p>                         |

|   |   |  |
|---|---|--|
| <p>[1] <b>SR - TEHNIČKI PODACI</b></p> <p>[2] Motor</p> <p>[3] Jednocilindrični dvotaktni</p> <p>[4] Kubikaža</p> <p>[5] Snaga</p> <p>[6] Broj obrtaja pri minimalnoj brzini</p> <p>[7] Maksimalni dozvoljeni broj obrtaja bez opterećenja s namontiranim lancem</p> <p>[8] Kapacitet rezervoara goriva</p> <p>[9] Kapacitet rezervoara za ulje</p> <p>[10] Specifična potrošnja pri maksimalnoj snazi</p> <p>[11] Smesa goriva (Benzin : Ulje 2-taktni)</p> <p>[12] Dužina sečenja</p> <p>[13] Debljina lanca</p> <p>[14] Zubi / korak zupčanika lanca</p> <p>[15] Maksimalna brzina lanca</p> <p>[16] Svecica</p> <p>[17] Težina (sa praznim rezervoarom, brez mač, lanac)</p> <p>[18] Dimenzije</p> <p>[19] Dužina</p> <p>[20] Širina</p> <p>[21] Visina</p> <p>[22] Nivo zvučnog pritiska (na osnovu standarda ISO 22868:2011)</p> <p>[23] Merna nesigurnost</p> <p>[24] Izmeren nivo zvučne snage (na osnovu standarda ISO 22868:2011)</p> <p>[25] Garantovan nivo zvučne snage</p> <p>[26] Vibracije koje se prenose na ruku na prednjoj dršci (na osnovu standarda ISO 22867:2011)</p> <p>[27] Vibracije koje se prenose na ruku na zadnjoj dršci (na osnovu standarda ISO 22867:2011)</p> <p>[28] OPCJE</p> <p>[29] Uredaj za zaštitu od smrzavanja</p> <p>[30] Dekompresijski ventili</p> <p>[32] TABELA ZA PRAVILNO KOMBINOVANJE MACA I LANCA (Pogl. 16)</p> <p>[33] KORAK</p> <p>[34] MAC</p> <p>[35] LANAC</p>            | <p>[36] MODEL</p> <p>[37] Inč</p> <p>[38] Dužina: Inč / cm</p> <p>[39] Širina zleba: Inč / mm</p> <p>[40] Sifra</p> <p>(*) PAŽNJA! Vrednost vibracija može varirati u zavisnosti od upotrebe mašine i njene opreme i može biti veća od navedene. Neophodno je utvrditi sigurnosne mere za zaštitu rukovoaca koje se moraju zasnivati na proceni opterećenja koje stvaraju vibracije u realnim uslovima upotrebe. U tu svrhu treba uzeti u obzir sve faze ciklusa rada, kao što su, na primer, gašenje ili rad na prazno.</p> <p>[1] <b>SV - TEHNIŠKA SPECIFIKACIONER</b></p> <p>[2] Motor</p> <p>[3] 2-takts encyldrigr</p> <p>[4] Cylindervolyrn</p> <p>[5] Effekt</p> <p>[6] Minimal varvtal</p> <p>[7] Maximalt varvtal tillåtet utan belastning med monterad kedja</p> <p>[8] Bränsletankens kapacitet</p> <p>[9] Oljetankens kapacitet</p> <p>[10] Specifik förbrukning vid maximal effekt</p> <p>[11] Bränsleblandning (Bensin: tvåtaktsolja)</p> <p>[12] Skärningslängd</p> <p>[13] Kedjans tjocklek</p> <p>[14] Tänder / kuggstångens tandavstånd på kedjan</p> <p>[15] Maximal hastighet kedjan</p> <p>[16] Tändstift</p> <p>[17] Vikt (med tom tank, utan stång, kedja)</p> <p>[18] Dimensioner</p> <p>[19] Längd</p> <p>[20] Bredd</p> | <p>[21] Höjd</p> <p>[22] Ljudtrycksnivå (enligt ISO 22868:2011)</p> <p>[23] Tvivel med mått</p> <p>[24] Uppmått ljudeffektiv (enligt ISO 22868:2011)</p> <p>[25] Garanterad ljudeffektiv</p> <p>[26] Vibrationer på handen på det främre handtaget (enligt ISO 22867:2011)</p> <p>[27] Vibrationer på handen på det bakre handtaget (enligt ISO 22867:2011)</p> <p>[28] TILLVAL</p> <p>[29] Frostskyddsanordning</p> <p>[30] Tryckavlastningsventil</p> <p>[32] TABELL FÖR RÄTT KOMBINATION AV SVÄRD OCH KEDJA (Kap. 16)</p> <p>[33] STEG</p> <p>[34] STÅNG</p> <p>[35] KEDJA</p> <p>[36] MODELL</p> <p>[37] Tum</p> <p>[38] Längd: Tum / cm</p> <p>[39] Rännans Bredd: Tum / mm</p> <p>[40] Kod</p> <p>(*) VARNING! Vibrationsvärdet kan variera i funktion till användningen av maskinen och dess utrustning och överstiga det som anges. Säkerhetsanordningar måste förutses för att skydda användaren och skall grundas sig på uppskattningen av den belastning som skapas av vibratorerna under verkliga användningsförhållanden. Av detta skäl skall samtliga faser under funktionscykeln tas hänsyn till, som till exempel en släckning eller funktion under tomgång.</p> |
| <p>[1] <b>TR - TEKNİK VERİLER</b></p> <p>[2] Motor</p> <p>[3] Tek silindirli 2 zamanlı</p> <p>[4] Silindir</p> <p>[5] Güç</p> <p>[6] Minimum devir sayısı</p> <p>[7] Zincir monte edilmiş iken, yük olmaksızın kabul edilebilir maksimum devir sayısı</p> <p>[8] Yakıt deposunun kapasitesi</p> <p>[9] Yağ deposunun kapasitesi</p> <p>[10] Maksimum güçte özgül tüketim</p> <p>[11] Karışım (Benzin : Yağ 2 zamanlı)</p> <p>[12] Kesim uzunluğu</p> <p>[13] Kalınlık zincir</p> <p>[14] Zincir pinyonunun dişleri / adımı</p> <p>[15] Maksimum hiz zinciri</p> <p>[16] Buji</p> <p>[17] Ağırılık (boş depo ile, pala, zincir olmadan)</p> <p>[18] Ebatlar</p> <p>[19] Uzunluk</p> <p>[20] Genişlik</p> <p>[21] Yükseklik</p> <p>[22] Ses basınç seviyesi (ISO 22868:2011'e dayalı)</p> <p>[23] Ölçü belirsizliği</p> <p>[24] Ölçülen ses güç seviyesi (ISO 22868:2011'e dayalı)</p> <p>[25] Garanti edilen ses güç seviyesi</p> <p>[26] Ön kabza üzerindeki ele aktarılan titreşim (ISO 22867:2011'e dayalı)</p> <p>[27] Arka kabza üzerindeki ele aktarılan titreşim (ISO 22867:2011'e dayalı)</p> <p>[28] SEÇENEKLER</p> <p>[29] Donma önleyici donanım</p> <p>[30] Dekompresyon vanası</p> <p>[32] DOĞRU PALA VE ZİNCİR BİRLEŞİMİ TABLOSU (Böl. 16)</p> <p>[33] ADIM</p> <p>[34] PALA</p> <p>[35] ZİNCİR</p> <p>[36] MODELİ</p> <p>[37] İnç</p> <p>[38] Uzunluk: İnç / cm</p> <p>[39] Yiv Genişliği: İnç / mm</p> <p>[40] Kod</p> | <p>(*) DİKKAT! Titreşimlerin değeri, makinenin kullanımına ve donatımına göre değişebilir ve belirlenen değerden fazla olabilir. Kullanıcıyı korumak için güvenlik tedbirlerinin belirlenmesi gerekir; bunlar, gerçek kullanım şartlarında titreşimler tarafından üretilen yükün tahminine dayanmalıdır. Bu amaçla işleme devrinin tüm aşamaları (örneğin kapanma veya boş işleme) dikkate alınmalıdır.</p>   |  |

**INDEX**

|  |    |
|--|----|
| 1. GENERAL INFORMATION .....                                       | 1  |
| 2. SAFETY REGULATIONS .....  | 2  |
| 3. GETTING TO KNOW THE MACHINE .....                               | 4  |
| 3.1 Description of the machine and planned use ..                  | 4  |
| 3.2 Safety signs .....   | 5  |
| 3.3 Product identification label .....                             | 5  |
| 3.4 Main components .....  | 5  |
| 4. ASSEMBLY .....  | 6  |
| 4.1 Assembly components .....                                      | 6  |
| 4.2 Assembly of the guide bar and toothed chain ..                 | 6  |
| 5. CONTROLS .....  | 7  |
| 5.1 Engine start/stop switch .....                                 | 7  |
| 5.2 Choke lever .....  | 7  |
| 5.3 Primer control button .....                                    | 7  |
| 5.4 Pressure relief valve control (for model SP 526<br>only) ..... | 7  |
| 5.5 Throttle trigger lever .....                                   | 7  |
| 5.6 Interlock lever .....  | 7  |
| 5.7 Handle for manual start .....                                  | 7  |
| 5.8 Chain brake .....  | 7  |
| 6. USING THE MACHINE .....   | 8  |
| 6.1 Preparation .....  | 8  |
| 6.2 Safety checks .....  | 9  |
| 6.3 Startup .....  | 9  |
| 6.4 Operation .....  | 10 |
| 6.5 Advice for operation .....                                     | 12 |
| 6.6 Stop .....   | 12 |
| 6.7 After operation .....  | 13 |
| 7. ROUTINE MAINTENANCE .....                                       | 13 |
| 7.1 General information .....                                      | 13 |
| 7.2 Preparing the fuel mixture .....                               | 13 |
| 7.3 Refuelling .....   | 14 |
| 7.4 Topping up the chain oil tank .....                            | 14 |
| 7.5 Cleaning the machine and the engine .....                      | 14 |
| 7.6 Cleaning the chain .....                                       | 14 |
| 7.7 Chain catcher .....  | 15 |
| 7.8 Nuts and bolts .....   | 15 |
| 8. EXTRAORDINARY MAINTENANCE .....                                 | 15 |
| 8.1 Machine and bar lubrication holes .....                        | 15 |
| 8.2 Cleaning the air filter .....                                  | 15 |
| 8.3 Clutch Housing .....   | 15 |
| 8.4 Chain drive sprocket .....                                     | 15 |
| 8.5 Checking the spark plug .....                                  | 15 |
| 8.6 Starter cable .....  | 15 |
| 8.7 Maintenance of the toothed chain .....                         | 15 |
| 8.8 Guide bar maintenance .....                                    | 16 |
| 8.9 Tuning minimum speed .....                                     | 16 |
| 8.10 Tuning the carburettor .....                                  | 16 |
| 9. STORING THE MACHINE .....                                       | 17 |
| 10. HANDLING AND TRANSPORTATION .....                              | 17 |
| 11. ASSISTANCE AND REPAIRS .....                                   | 17 |
| 12. WARRANTY COVERAGE .....  | 17 |
| 13. MAINTENANCE TABLE .....  | 18 |
| 14. CHAIN MAINTENANCE TABLE .....                                  | 19 |
| 15. PROBLEM IDENTIFICATION .....                                   | 19 |
| 16. ACCESSORIES .....  | 20 |

**1. GENERAL INFORMATION****1.1 HOW TO READ THE MANUAL**

Some paragraphs in the manual contain important information regarding safety and operation and are emphasized in this manner:

**NOTE** or **IMPORTANT** *these give details or further information on what has already been said, and aim to prevent damage to the machine.*

The  symbol highlights danger. Non-compliance with the warning could lead to personal and/or third party injury and or damage.

.....  
 • The paragraphs highlighted in a square with .....  
 • grey spots indicate the optional characteristics .....  
 • not on all models documented in this manual. ....  
 • Check if the characteristic is on this model. ....  
 .....

Whenever reference is made to a position on the machine "front", "back", "left" or "right" hand side, this refers to the operator's working position.

**1.2 REFERENCES****1.2.1 Figures**

The figures in these instructions for use are numbered 1, 2, 3, etc. Components shown in the figures are marked A, B, C, etc. A reference to component C in figure 2 is written: "See fig. 2.C" or simply "(Fig. 2.C)". The figures are given as a guide only. The actual parts may vary from those shown.

**1.2.2 Titles**

The manual is divided into chapters and paragraphs. The title of paragraph "2.1 Training" is a sub-title of "2. Safety regulations". References to titles or paragraphs are marked with the abbreviation chap. or par. and the relevant number. Example: "chap. 2" o "par. 2.1".

## 2. SAFETY REGULATIONS

### 2.1 TRAINING

 **Become acquainted with the controls and the proper use of the machine. Learn how to stop the machine quickly. Failure to follow the warnings and instructions may result in fire and/or serious injury.**

- Never allow children or persons unfamiliar with these instructions to use the machine. Local regulations may restrict the age of the operator.
- Never use the machine if the user is tired or unwell, or has taken medicine, drugs, alcohol or any substances which may slow their reflexes and compromise their judgement.
- Bear in mind that the operator or user is responsible for accidents or unexpected events occurring to other people or their property. It is the user's responsibility to assess the potential risk of the area where work is to be carried out, and to take all the necessary precautions to ensure his own safety and that of others, particularly on slopes or rough, slippery and unstable ground.
- If the machine is sold or lent to others, make sure that the operator looks over the user instructions contained in this manual.
- It takes specific training to use the machine for felling and delimiting.

### 2.2 PREPARATION

#### Personal Protective Equipment (PPE)

- Always wear slim fitting protective clothing with slash-proof protection, anti-vibration gloves, helmet, protective goggles, half-mask respirator, protective earplugs, cut resistant safety boots with non-slip soles.
- Never wear scarves, shirts, necklaces, bracelets, clothing with flowing parts, laces or ties or any hanging or flapping accessory that could catch in the machine or in any objects or materials in the work area.
- Tie your hair back if it is long.

#### Internal combustion engines: fuel

-  **DANGER!** Petrol and the fuel mixture are highly flammable!
- Keep the petrol and fuel mixture in approved fuel containers, in a safe place, away from any naked lights or heat sources.
- Keep the fuel containers and storage area free of sawdust, branches, leaves, or excessive grease.

- Keep the containers out of the reach of children.
- Do not smoke when preparing the mixture, when filling or topping up with fuel or when handling the fuel.
- Use a funnel to top up with fuel only in the open air.
- Do not inhale fuel fumes.
- Never remove the tank cap or add fuel whilst the engine is running or when the engine is hot.
- Open the fuel tank slowly to allow the pressure inside to decrease gradually.
- Do not approach the tank opening with a naked flame to check its contents.
- If you have spilt some fuel, do not attempt to start the engine but move the machine away from the area of spillage and avoid creating any source of ignition until the fuel has evaporated and fuel vapours have dissipated.
- Immediately clean up all traces of fuel spilt on the machine or on the ground.
- Replace caps of all fuel tanks and containers securely.
- Never start the machine in the same place in which you refilled it with fuel; the engine must be started in an area at least 3 metres from where you refuelled.
- If fuel is spilt on clothing, change clothing before starting the engine.

### 2.3 DURING OPERATION

#### Work Area

- Do not operate the engine in a confined space where dangerous carbon monoxide fumes can develop. All starting operations must be carried out in an open or well ventilated area! Always remember that exhaust fumes are toxic.
- When starting up the machine, do not direct the silencer and therefore the exhaust fumes towards flammable materials.
- Do not use the machine in environments at risk of explosion, in the presence of flammable liquids, gas or powder. Electrical contacts and mechanical friction can generate sparks that can ignite the powder or vapours.
- Work only in daylight or with good artificial light in good visibility conditions.
- Keep persons, children and animals away from the working area. Ask another adult to keep the children under supervision.
- Check that there is anybody within at least 15 metres of the machine's range of action.
- Where possible, avoid working on wet, slippery ground or in any case on uneven or steep ground that does not guarantee stability for the operator;

- Pay careful attention to uneven ground hills, dips, slopes, hidden hazards and obstacles than could limit visibility.
- Be very careful near ravines, ditches or embankments.
- Look out for traffic when using the machine near the road.
- To avoid the risk of fire, do not leave the machine with the engine hot on leaves, dry grass or other flammable material.

### Behaviour

- When running, the machine must always be firmly held in both hands, (left hand on the front hand grip and the right hand on the rear hand grip, even if the operator is left-handed) at a safe distance from all body parts.
- Always use caution and take on a firm and well balances position.
- Avoid using unstable ladders or platforms.
- Avoid working alone or in an isolated place, in case you have to find help after an accident.
- Never run, always walk.
- Make sure the bar does not come into violent contact with foreign bodies/obstacles and try to prevent any material from being hurled by the moving chain. Kickback may occur if the bar comes into contact with an obstacle. Kickback occurs when the tip of the chain comes in contact with an object or when the wood contracts and jams the chain during sawing. This contact with the tip of the chain can cause a rapid backward motion, pushing the guide bar up and towards the operator. This also happens when the chain is jammed along the upper part of the bar. In both cases, kickback can cause the operator to lose control of the chainsaw, leading to serious consequences. To prevent kickbacks, take all appropriate precautions provided below:
  - Hold the saw firmly, with the thumbs and fingers around the chainsaw grips, and position your body and arms so that you can resist the force of a kickback.
  - Do not fully extend the arms and do not saw above shoulder height.
  - Only used the guide bar and chains recommended by the manufacturer.
  - Follow the manufacturer's instructions regarding sharpening and maintenance of the chainsaw.
- Avoid exposure to dust and sawdust produced by the chain when cutting.
- Do not touch the engine parts which heat up during use. Burns hazard.
-  If something breaks or an accident occurs during work, turn off the engine immediately and move the machine away to prevent further damage; if an accident

occurs with injuries or third parties are injured, carry out the first aid measures most suitable for the situation immediately and contact the medical authorities for any necessary health care. Carefully remove any debris which could cause damage or injury to persons or animals if ignored.

-  Prolonged exposure to vibrations can cause injuries and neurovascular disorders (also called "Raynaud's syndrome" or "white hand"), especially to people suffering from circulation disorders. The symptoms appear in the hands, wrists and fingers and are shown through loss of sensitivity, torpor, itching, pain and discolouring of or structural changes to the skin. These effects can be worsened by low ambient temperatures and/or by gripping the hand grips excessively tightly. If the symptoms occur, the length of time the machine is used must be reduced and a doctor consulted.

### Use limitations

- Do not use the machine if you are unable to hold it with both hands or keep it steady on your legs while working.
- Never use the machine with damaged, missing or incorrectly positioned guards.
- Don't use the machine if the attachments/tools are not installed in their seats.
- Never disengage, deactivate, remove or tamper with the safety systems/microswitches installed.
- Do not alter the engine adjustments, nor over-run it. If the engine is forced to work with an excessive number of rotations, the risk of personal injury increases.
- Do not strain the machine too much and do not use a small machine for heavy duty work. If you use the right machine, you will reduce the risk of hazards and improve the quality of your work.

## 2.4 MAINTENANCE, STORAGE

Ensure regular maintenance and correct storage to maintain machine safety and high performance levels.

### Maintenance

- To reduce the risk of fire, regularly check the machine for oil and/or fuel leaks.
-  The noise and vibration levels shown in these instructions are the maximum levels for use of the machine. The use of an unbalanced cutting element, the excessive speed of movement, or the absence of maintenance have a significant influence on noise



emissions and vibrations. Consequently, it is necessary to take preventive steps to eliminate possible damage due to high levels of noise and stress from vibration. Maintain the machine well, wear ear protection devices and take breaks whilst working.

### Storage

- Do not store the machine with fuel in the tank in an area where fuel vapours could reach a naked light, a spark or a strong heat source.
- To reduce fire risks, do not leave containers with debris inside a room.

## 2.5 ENVIRONMENTAL PROTECTION

Safeguarding the environment must be a relevant and priority aspect of machine use, of benefit to the community and the environment we live in.

- Avoid being a disturbance to the neighbourhood. Use this machine at reasonable times of the day only (not early morning or late evening when the noise could cause disturbance).
- A certain amount of chain lubricating oil is released into the environment when the machine is running, so only use biodegradable oils made specifically for this use. Use of a mineral oil or engine oil causes serious damage to the environment.
- Adhere strictly to the local regulations governing the disposal of packaging, oil, fuel, filters, damaged parts or any other element which may have an impact on the environment; this waste should not be disposed of along with standard household waste, but must be disposed of separately and sent to special waste disposal facilities for handling and recycling.
- Comply with local regulations for the disposal of waste materials
- When the machine is withdrawn from service, do not dispose of it in the environment, but take it to a waste disposal facility in accordance with the local regulations in force.

## 3. GETTING TO KNOW THE MACHINE

### 3.1 DESCRIPTION OF THE MACHINE AND PLANNED USE

This machine is a forestry tool and precisely a chainsaw designed for forestry work.

The machine is essentially composed of a 2-stroke internal combustion engine, fuelled by an air-cooled oil-petrol mix, and a guide bar that drives the power from the engine to the toothed chain that acts as a fully fledged saw. The movement is transmitted from the engine to the chain by a centrifugal clutch that prevents the chain from moving when the engine is running at minimum speed.

The operator is able to operate the machine with two hands, using the front and rear hand grips, and use the main controls, always remaining at a safe distance from the cutting means.

### 3.1.1 Intended use

This machine was designed and manufactured for:

- felling, bucking and delimiting trees with dimensions suitable for the length of the guide bar or wooden objects with the same characteristics;
- use by one operator.

### 3.1.2 Improper use

Any other usage not in keeping with the above-mentioned ones may be hazardous and harm persons and/or damage things. Examples of improper use may include, but are not limited to:

- trimming hedges;
- carving operations;
- sectioning pallets, crates and various packing materials;
- sectioning furniture or other materials with nails, screws or other metal components;
- butchering meat;
- using the machine to cut materials other than wood (plastic materials, building materials);
- using the machine to lift, move or split objects;
- using the machine while fastened to fixed supports;
- using cutting means other than those found in the "Technical Data" table. Serious injury and wound hazard.
- use of the machine by more than one person.

**IMPORTANT** *Improper use of the machine will invalidate the warranty, relieve the Manufacturer from all liability, and the user will consequently be liable for all and any damage or injury to himself or others.*

### 3.1.3 User types

This machine is intended for use by consumers, i.e. non-professional operators. The machine is intended for "DIY" use only.

## 3.2 SAFETY SIGNS

The machine has various symbols on it (Fig. 2). They are used to remind the operator of the behaviour to follow to use it with the necessary attention and caution.

Meaning of symbols:



**WARNING! DANGER!** Failure to use this machine correctly can be hazardous for oneself and others



**WARNING!** Read the instruction manual before using the machine.



Anyone operating the machine under normal conditions for continuous daily use may be exposed to a noise level equal to or exceeding 85 dB (A). Wear ear protectors, safety goggles and a protective helmet.



Wear gloves and safety boots!



### **BEWARE OF KICKBACK!**

Kickback is the rapid and uncontrollable backward motion of the chainsaw in the direction of the operator. Always work in complete safety. Use chains with safety links that limit kickback.



Never hold the machine with one hand! Hold the machine fast with both hands to control the machine and reduce the risk of kickback.

**IMPORTANT** Any damaged or illegible decals must be replaced. Order replacement decals from an Authorised Service Centre.

## 3.3 PRODUCT IDENTIFICATION LABEL

The product identification label provides the following data (Fig. 1):

1. Sound power level
2. Conformity marking
3. Year of manufacture
4. Type of machine
5. Serial number
6. Name and address of Manufacturer
7. Article code
8. Emission number

Write the identification data of the machine in the specific space on the label on the back of the cover page.

**IMPORTANT** Quote the information on the product identification label whenever you contact an Authorised Service Centre.

**IMPORTANT** The example of the Declaration of Conformity is provided on the last pages of the manual.

## 3.4 MAIN COMPONENTS

The machine is made up of the following main components (Fig. 1):

- A. **Engine:** supplies the drive power to the cutting means.
- B. **Front hand grip:** support hand grip located on the front of the chainsaw. This should be grasped using the left hand.
- C. **Rear hand grip:** support hand grip located on the rear of the chainsaw. This should be grasped using the right hand. This hand grip is fitted with the main throttle controls.
- D. **Front hand guard:** protection device seated between the front hand grip and the toothed chain, to protect the hand against injuries should it slip off the hand grip. This guard is used as a device to trigger the chain brake (par. 5.7).
- E. **Rear hand guard:** protection device seated in the lower right section of the rear hand grip, to protect the hand from the chainsaw should it break or disconnect from the guide bar.
- F. **Guide bar:** supports and guides the toothed chain.

- G. **Toothed chain:** cutting element, consisting of drive links fitted with small blades called "teeth" and side connections held in place by rivets.
- H. **Chain restraint pin:** safety device that prevents uncontrolled movements of the toothed chain should it break or slacken.
- I. **Spiked bumper:** device installed opposite the guide bar assembly point acting as a pivot when it comes into contact with a tree or trunk.
- J. **Spiked bumper guard:** spiked bumper cover to be fitted during handling, transportation or storage of the machine. This guard must be removed when using the machine.
- K. **Bar cover guard:** chainsaw cover on the guide bar to be fitted during handling, transportation or storage of the machine.

## 4. ASSEMBLY

**IMPORTANT** *The safety regulations to follow during machine use are described in Chapter 2. Strictly comply with these instructions to avoid serious risks or hazards.*

For storage and transport purposes, some components of the machine are not installed in the factory and have to be assembled after unpacking. Follow the instructions below.

**⚠ Unpacking and completing the assembly should be done on a flat and stable surface, with enough space for machine handling and its packaging, always making use of suitable equipment. Do not use the machine until all the instructions provided in the "ASSEMBLY" section have been carried out.**

### 4.1 ASSEMBLY COMPONENTS

The packaging holds the components needed for assembly as listed in the table below:

|  |
|--|
| Description  |
| Guide bar fitted with bar cover                                |
| Toothed chain  |
| Key (housed below the lower section of the machine) (Fig. 1.M) |
| Cutting chain sharpening filing tool                           |
| Documentation  |

#### 4.1.1 Unpacking

1. Carefully open the packaging, paying attention not to lose components.

2. Consult the documentation in the box, including these instructions.
3. Remove all the unassembled parts from the box.
4. Remove the machine from the box.
5. Dispose of the box and packaging in compliance with local regulations.

### 4.2 ASSEMBLY OF THE GUIDE BAR AND TOOTHED CHAIN

**⚠ Always wear heavy duty gloves when handling the bar and chain. Mount the bar and chain very carefully so as not to impair the safety and efficiency of the machine. If in doubt, contact your dealer.**

**⚠ Perform all operations with the engine off.**

**⚠ Before assembling the bar, check that the chain brake is not engaged (par. 5.7).**

1. Loosen all the nuts (Fig. 3.A) and remove the clutch cover (Fig. 3.B) to get to the drive sprocket and the point where the bar is fitted.
2. Remove the plastic spacer (Fig. 3.C); this spacer must be used exclusively when transporting the machine in its packaging and must not be used at any other time.
3. Mount the bar (Fig. 4.A) by inserting the stud bolts (Fig. 4.B) in the groove (Fig. 4.C) and push it towards the back of the machine body.
4. Mount the chain (Fig. 5.A) around the drive sprocket (Fig. 5.B) and along the bar guide (Fig. 5.C), making sure it is fitted in the right direction (Fig. 5.D).



Direction in which the chain runs

If the tip of the bar is equipped with a nose sprocket, make sure the drive links are correctly inserted in the sprocket rims (Fig. 6).

5. Check that chain tension adjuster pin (Fig. 7.A) is fitted properly into the hole on the bar; if it isn't, turn the chain tension adjuster screw using a screwdriver (Fig. 7.B), until the pin is completely inserted.
6. Refit the guard without fully tightening the nuts.
7. Turn the chain tension adjuster screw (Fig. 8.A) to achieve the desired tension.
8. Raise the bar and tighten the guard nuts securely using the wrench (Fig. 9).

#### 4.2.1 Checking the chain tension

Check the chain tension.

The tension is correct when the drive links do not slip out of the chain guides if you hold the chain in the middle of the bar (Fig. 10).

## 5. CONTROLS

### 5.1 ENGINE START/STOP SWITCH

Used to start and stop the engine (Fig. 11.C).



The engine can start and run.



The engine stops.

After pressing the stop switch, the switch automatically returns to the start position "I".

### 5.2 CHOKE LEVER

Used to turn on the engine when cold. The choke control has two positions:



Position A (Fig. 11.A) - the choke is not engaged (normal operations and warm start)..



Position B (Fig. 11.B) - the choke is engaged (for a cold start)..

### 5.3 PRIMER CONTROL BUTTON



Press the rubber button of the primer (Fig. 12.A) to inject fuel into the carburettor intake manifold to facilitate startup when the engine is cold.

### 5.4 PRESSURE RELIEF VALVE CONTROL (FOR MODEL SP 526 ONLY)

Press the valve (Fig. 13.E) to reduce the compression of the cylinder and to start the machine more easily.

### 5.5 THROTTLE TRIGGER LEVER

Used to regulate the chain speed.

The throttle trigger lever (Fig. 12.B) can only be used if the throttle interlock lever is pressed simultaneously (Fig. 12.C).

The correct running speed will be achieved by pressing the throttle trigger lever (Fig. 12.B) as far as possible.

### 5.6 INTERLOCK LEVER

The interlock lever (Fig. 12.C) allows the throttle trigger lever to be used (Fig. 12.B).

### 5.7 HANDLE FOR MANUAL START

For manual engine start-up (Fig. 11.D).

### 5.8 CHAIN BRAKE

This is a safety braking system that blocks the chain movement when kickback occurs during cutting. Kickbacks occur following an irregular contact of the tip of the bar with a rapid upward movement of the bar that causes the hand to strike the front guard (Fig. 1.D). It must be manually released to disengage the chain brake.



Chain brake disengaged. This is achieved when the front hand guard (Fig. 1.D) is pulled all the way back towards the front hand grip until it clicks into position.



Chain brake engaged. This is achieved when the front hand guard (Fig. 1.D) is pushed all the way forward.

**⚠ Do not use the machine if the chain brake does not function correctly and have it inspected by your dealer.**

## 6. USING THE MACHINE

**IMPORTANT** *The safety regulations to follow during machine use are described in Chapter 2. Strictly comply with these instructions to avoid serious risks or hazards.*

### 6.1 PREPARATION

Before starting to work, it is necessary to carry out several checks and operations to ensure you can work efficiently and in maximum safety.

**IMPORTANT** *The machine is supplied with the fuel and chain lubrication oil tanks empty.*

#### 6.1.1 Refuelling

Fill with fuel before using the machine. For preparing the mixture, refuelling methods and precautions see paragraph 7.3.

#### 6.1.2 Filling with chain lubrication oil

Fill with chain lubrication oil before using the machine. For oil filling methods and precautions see paragraph 7.4.

#### 6.1.3 Checking the chain tension

 **Perform all operations with the engine off.**

 **Always wear heavy duty gloves.**

Check the chain tension.  
The tension is correct when the drive links do not slip out of the chain guides if you hold the chain in the middle of the bar (Fig. 10).

To adjust the chain tension:

1. loosen the cover nuts, using the supplied wrench;
2. turn the chain tension adjuster screw (Fig. 8.A) to achieve the desired tension;
3. raise the bar and tighten the guard nuts securely using the wrench (Fig. 9).

 **Never work with the chain loose as it can be hazardous if the chain slips out of the bar guides.**

**IMPORTANT** *During the first period of use it must be checked more frequently due to settling of the chain.*

#### 6.1.4 Preparing the machine before starting work

##### • Anti-freeze device

When using the chainsaw at temperatures under +5°C, it is necessary to change the anti-freeze device settings before starting the machine to prevent ice from forming inside the carburettor, which will result in a loss in engine power or erratic engine performance.

The machine is equipped with an air vent hatch on the cylinder lid, to allow warm air flow to the engine.

In normal operating conditions (temperatures above +5°C), use the machine in standard operating mode, i.e. using factory default settings.

To switch from "Normal " mode to "Anti-freeze " mode (and vice versa):

1. stop the machine (par. 6.6);
2. remove the air filter cover and the air filter (par. 8.2);

##### 3.a on models SP386, SP 426:

- remove the anti-freeze cap from its housing to the right of the cylinder cover (Fig. 14.A);
- Turn the anti-freeze cap so that the «SNOW» symbol is facing downwards to leave the air vent hatch open (Fig. 14.B);

##### 3.b on models SP466, SP 526:

- unscrew the screws which secure the cylinder cover in place (Fig. 15.A) (2 screws inside and one outside) and remove the cylinder cover. (Fig. 15.B);
  - remove the anti-freeze cap from its housing (Fig. 16.A), in the centre and at the back of the cylinder cover (Fig. 16.B);
  - Turn the anti-freeze cap so that the «SNOW» symbol is facing downwards (Fig. 17.A) to leave the air vent hatch open (Fig. 17.B);
  - remount the cylinder cover.
4. remount the air filter cover and the relative cover (par. 8.2).

**NOTE** *If the machine is used in anti-freeze mode at temperatures above +5°C, this may cause difficulties when starting the engine and during use due to the incorrect engine speed. Always check that the machine is switched to standard mode (anti-freeze cap with the «SUN» symbol facing sideways and the air vent hatch closed) if there is no danger of ice forming.*

## 6.2 SAFETY CHECKS

Run the following safety checks and check that the results correspond to those outlined on the tables.

 **Always carry out the safety checks before use.**

 **Always carry out daily inspection before use and after dropping or other impacts to identify significant damage or defect.**

### 6.2.1 General check

| Object                                 | Result   |
|--|--|
| Hand grips and guards (Fig. 1.B - 1.E) | Clean, dry, without traces of oil and grease, and fixed correctly and firmly to the machine. |
| Screws on the machine and bar          | Correctly tightened (not loose)  |
| Guide bar (Fig. 1.F)                   | Properly installed.  |
| Chain (Fig. 1.G)                       | Sharp, not damaged or worn, mounted and tensioned correctly.                                 |
| Air filter (Fig. 38.B)                 | Clean  |
| Electric cables and spark plug cable   | Undamaged to prevent sparks.   |
| Spark plug cap (Fig. 31.A)             | Undamaged and fitted correctly on the spark plug   |

### 6.2.2 Machine operating test

| Action  | Result  |
|---|---|
| Start the machine (par. 6.3)  | The chain (Fig. 1.G) must not move when the engine is running idle.<br> <b>Do not use the machine if the chain moves when the engine is running idle; in this case, contact your dealer.</b> |
| Engage the throttle trigger lever (Fig. 12.B) and the interlock lever simultaneously (Fig. 12.C). | The levers must move freely and not be forced. The chain moves.   |

| Action  | Result   |
|---|--|
| Release the throttle trigger lever (Fig. 12.B) and the interlock lever (Fig. 12.C).   | The levers must return automatically and rapidly to the neutral position, the engine must return to running idle and the chain must be stationary.                     |
| Engage the throttle trigger lever (without pressing the interlock lever) (Fig. 12.B).   | The throttle trigger lever remains blocked.  |
| Press the engine start/stop switch (Fig. 11.C)  | The switch must move easily from one position to another and must return automatically to the start position when released.  |
| <b>CHECKING THE CHAIN BRAKE</b><br>1. Start the machine (par. 6.3):<br>2. Grasp the hand grips firmly with both hands.<br>3. Use the throttle lever to keep the chain moving, push the front hand guard forwards using the back of your left hand;(par. 5.7). | 3. The chain must stop moving immediately.<br><br>When the chain has stopped, immediately release the throttle trigger lever and disengage the chain brake (par. 5.7). |

 **If any of the results fails to match the instructions provided in the following table, do not use the machine! Take it to an Authorised Service Centre to be checked and repaired if necessary.**

## 6.3 STARTUP

**IMPORTANT** A label (Fig. 2) is placed on the machine that summarizes the start up main steps. The label is a quick guide and it does not replace the procedures specified below.

Before starting the machine:

1. Place the machine firmly on the ground.
2. Remove the bar cover guard (Fig. 1.K) and the spiked bumper guard (Fig. 1.J) (if fitted).
3. Make sure the bar and the chain are not touching the ground or any other object.

4. Make sure the chain brake is engaged (par. 5.7).

**IMPORTANT** *To avoid breaking the starter cable, do not pull the whole length of it or let it slide along the edge of the cable guide hole. Release the starter hand grip gradually, to prevent it flying back uncontrollably.*

**IMPORTANT** *Never wind the starter cable around your hand.*

**!** *Never start the chainsaw by holding on to the starter cable and allowing it to fall. This is an extremely dangerous method as you lose complete control over the machine and the chain.*

**NOTE** *The switch is always in the start position (par. 5.1).*

### 6.3.1 Startup from cold

**!** *A "cold " start of the engine means starting it after at least 5 minutes from when it was switched off or after refuelling.*

1. Engage the choke by turning the lever to position «B» (Fig. 11.B).
2. Press the primer device button (Fig. 12.A) 6 times to prime the carburettor.

3. **For model SP 526 only:**  
Press the pressure relief valve (Fig. 13.E).

**NOTE** *Immediately after the engine starting, the valve automatically returns to its original position.*

4. Hold the machine firmly on the ground with your hand on the front hand grip and your foot in the rear hand grip, to avoid losing control during starting (Fig. 18).

**!** *If the machine is not held firmly, the force of the engine could cause the user to lose his balance or direct the bar towards him or an obstacle.*

5. Pull the starter hand grip slowly for 10 - 15 cm until you feel some resistance, then pull it 4 times until you hear the engine start to tick over. Engine will not start at this stage.

**IMPORTANT** *Do not pull the starter hand grip more than 4 times.*

6. Disengage the choke (Fig. 11.A) by turning the lever to position «A».

7. Pull the starter grip again until the engine starts as normal.
8. When the engine has started, simultaneously activate the throttle trigger lever (Fig. 12.B) and the interlock lever briefly (Fig. 12.C) to cancel fast tick over. Allow the engine to run idle for 10-15 seconds.
9. Disengage the chain brake (par. 5.7).

**IMPORTANT** *Do not let the engine run at high speed with the chain brake engaged, as this could cause overheating and damage to the clutch.*

10. Let the engine run idle for at least 1 minute before using the machine.

**IMPORTANT** *If the starter hand grip is pulled repeatedly with the choke engaged, it may flood the engine and make starting difficult. " If the engine floods (see paragraph 15.5).*

### 6.3.2 Warm start

When hot starting (immediately after stopping the engine):

1. Press the primer device button (Fig. 12.A) 6 times to prime the carburettor.

2. **For model SP 526 only:**

Press the pressure relief valve (Fig. 13.E).

**NOTE** *Immediately after the engine starting, the valve automatically returns to its original position.*

3. Engage the choke (position «B» - par. 5.2) and then immediately disengage again (position «A» - par. 5.2); this will engage the fast tick over.
4. Follow points 4 - 7 - 8 - 9 in the previous procedure (par. 6.3.1).

## 6.4 OPERATION

Before felling or delimiting for the first time, make sure:

- you have been specifically trained to use this type of equipment;
- you have carefully read the safety regulations and user instructions contained in this manual;
- you practise first on logs on the ground or attached to trestles, in order to get familiar with the machine and the most suitable cutting techniques.

To operate with the machine proceed as described below:

- Always disengage the chain brake, before using the throttle control.
- The machine must always be firmly held in both hands, with the left hand on the front hand grip and the right hand on the rear hand grip, even if the operator is left handed.

**⚠ Stop the machine immediately if the chain stops during sawing.**

#### 6.4.1 Checks to be conducted whilst working

##### 6.4.1.a Checking the chain tension

The chain tends to stretch gradually as you work, so you need to check its tension frequently (par. 6.1.3).

##### 6.4.1.b Checking the oil delivery

**IMPORTANT** *Never use the machine without lubrication! The oil tank may also be empty every time the fuel runs out. Make sure you top up the oil tank every time you refuel the machine (par. 7.4).*

**⚠ Make sure the bar and the chain are in place when you check the oil delivery.**

Start the engine (par. 6.3), keep it running at medium power and check if the chain oil is delivered as shown in (Fig. 19).

You can adjust the chain oil flow using a screwdriver on the pump adjuster screw (Fig. 20.A) which is on the bottom of the machine.

This is the symbol that identifies the oil pump regulator:



Use a screwdriver to turn it to the "+" position to increase the oil flow to the chain; turn it to the "-" position to decrease the flow.

#### 6.4.2 Work techniques

##### 6.4.2.a Delimiting a tree

**⚠ Make sure there is nothing or anybody in the area where the branches will fall.**

1. Stand opposite the branch you want to cut.
2. Start cutting lower branches followed by the higher ones.
3. Cut downwards to prevent the bar from getting jammed (Fig. 21).

##### 6.4.2.b Felling a tree

**IMPORTANT** *Where two or more persons are working together on felling and bucking operations, such operations must be performed in separate areas at a distance from each other of at least 2.5 times the height of the tree being felled. Do not fell trees if this involves risks of injuring people, coming into contact with a power line or causing any form of damage. If the tree should come into contact with a main power line, report the incident immediately to the network provider.*

Before commencing the felling operations:

- it is necessary to evaluate the natural inclination of the tree, the part where the branches are larger and the wind direction, to assess how the tree will actually fall;
- remove any dirt, stones, pieces of bark, nails, metal staples and wire;
- clear the area around the tree and find a stable place to stand;
- plan obstacle-free escape routes at a 45° angle back and away from the direction of the fall (Fig. 22) which allow the operator to escape to a safe zone, approximately 2.5 times the height of the tree being felled;
- Stand upstream of the land onto which the tree will probably roll or fall over after felling.

##### • Performing a face notch

1. Following the directional marks on the chainsaw (Fig. 23.A), point towards a target on the ground in the direction in which you intend to fell the tree (Fig. 23.B).
2. Stand to the right of the tree, behind the chainsaw.
3. Saw a horizontal face notch to 1/3 of the diameter of the tree, perpendicular to the direction in which it will fall (Fig. 24.A).

##### • Felling back cut

4. Perform the felling back cut at least 5 cm higher than the horizontal face notch (Fig. 24.B).
5. Perform the felling back cut leaving sufficient wood to act as a "hinge" (Fig. 24.C). The hinge wood will prevent the tree from twisting and falling in the wrong direction. Do not cut through the hinge.



6. Reduce the thickness of this hinge without pulling out the bar, until the tree falls.
7. If there is any risk of the tree not falling in the desired direction, or that it might lose its balance moving backwards and bending the toothed chain, stop cutting before completing the felling back cut and use some wooden, plastic or aluminium wedges (Fig. 24.D) to open the cut. Force the tree to fall along the desired line by hitting the wedges with a sledge hammer.
8. When the tree starts to fall, it is necessary to withdraw the machine from the cut, switch it off (par. 6.6), lie it on the ground and take the foreseen exit route. Beware of falling branches and pay attention where you put your feet.

#### 6.4.2.c Limbing tree branches

Limbing means removing the branches from a felled tree.

**⚠ Be careful of where the branches are lying on the ground, the risk of them being under tension, the direction the branch may go during cutting and the risk of the tree being unstable after the branch has been cut.**

When limbing, it is necessary to leave the lower, larger branches to support the trunk on the ground. Remove the small branches with a single blow (Fig. 25.A). It is recommended to cut the tensioned branches working from the bottom upwards to prevent the chainsaw from bending (Fig. 25.B).

#### 6.4.2.d Bucking the trunk

Bucking means sawing a tree trunk into logs.

It is essential to make sure your feet are positioned firmly on the ground, and your weight is distributed equally on both feet. If possible, it is recommended to raise and support the trunk using branches, logs or blocks of wood.

It is easier to saw a log using the spiked bumper (Fig. 1.I):

1. plant the spiked bumper into the log and use it as a pivot. Cut with an arched motion to make the bar penetrate the wood (Fig. 26);
2. repeat several times if necessary, changing the point where you plant the spiked bumper.

#### • Trunk lying on the ground

When the entire trunk is lying on the ground, it is bucked from the top down (overbucking) (Fig. 27.A).

- Cut up to half the diameter, roll the log over and finish sawing on the other side.

#### • Trunk resting on one end only

When the trunk is resting on one end only:

- saw through 1/3 of the diameter from the bottom up (underbucking) (Fig. 28.A);
- then perform the final cut, overbucking to reach the first cut (Fig. 28.B).

#### • Trunk resting on both ends

When the trunk is resting on both ends:

- saw through 1/3 of the diameter from the top down (overbucking) (Fig. 29.A);
- then perform the final cut, underbucking the lower 2/3 to reach the first cut (Fig. 29.B).

#### • Sloping trunk

Always stand upstream when bucking a sloping trunk (Fig. 30).

During the operation, to maintain control when the cut is almost complete, reduce the bucking pressure without removing your hands from the machine hand grips. Take all necessary precautions to prevent the machine from coming into contact with the ground.

### 6.5 ADVICE FOR OPERATION

**NOTE** *Avoid using the machine at full power for the first 6- 8 working hours.*

**IMPORTANT** *Stop the machine (par. 6.6) when moving between work areas.*

### 6.6 STOP

To stop the machine:

1. Release the throttle trigger lever (Fig. 12.B) and allow the engine to run at idle speed for a few seconds.
2. Turn the switch (Fig. 11.C) to the «O» position.
3. Wait until the chain is stationary.

**⚠ When you have reduced speed to a minimum, it will take a few seconds for the chain to stop.**

**⚠ The engine may be very warm immediately after it is shut off. Do not touch. The engine can cause burn injuries.**

## 6.7 AFTER OPERATION

- Remove the spark plug cap (Fig. 31.A).
- Mount the bar cover.
- Allow the machine to cool down.
- Loosen the rod fastening nuts to reduce chain tension.
- Carefully remove any dust and debris and remove all traces of sawdust or oil deposits from the chain. (par. 7.5, par. 7.6).
- Check there are no loose or damaged components. If necessary, replace the damaged components and tighten any screws and loose bolts.

**IMPORTANT** Stop the machine (par. 6.6), remove the spark plug cap (Fig. 31.A) and mount the bar cover whenever the machine is unused or left unattended.

## 7. ROUTINE MAINTENANCE

### 7.1 GENERAL INFORMATION

**IMPORTANT** The safety regulations to follow during machine use are described in Chapter 2. Strictly comply with these instructions to avoid serious risks or hazards.

 **Before conducting any inspections, cleaning or maintenance/adjustment interventions on the machine:**

- Stop the machine;
- Wait until the chain is stationary;
- Apply the bar cover, except when working directly on the chain or bar itself.
- Remove the spark plug cap (Fig. 31.A);
- Wait until the engine is sufficiently cold;
- Read the relevant instructions;
- Use suitable clothing, protective gloves and goggles;

- The frequency and types of maintenance are summarised in the "Maintenance Table" (see chapter 12). The table will help you maintain your machine's safety and performance. It summarises the main interventions to be made and the frequency applicable to each of them. Carry out the relevant intervention according to the first deadline.
- The use of non-genuine spare parts and attachments could adversely affect machine operation and safety. The manufacturer shall decline all liability in the event of injuries or damages caused by such parts.
- Genuine spare parts are supplied by Authorized Service Centres and Dealers.

- Never use the machine with worn or damaged parts. Damaged parts are to be replaced and never repaired.

**IMPORTANT** All the maintenance and adjustment operations not described herein must be carried out by your dealer or Authorised Service Centre.

### 7.2 PREPARING THE FUEL MIXTURE

This machine has a two-stroke engine which requires a mixture of petrol and lubricating oil.

**IMPORTANT** Using petrol alone will damage the engine and will void the warranty.

**IMPORTANT** Only use quality fuels and oils to maintain high performance and guarantee the duration of the mechanical parts over time.

#### 7.2.1 Petrol characteristics

Only use unleaded petrol with an octane rating of at least 90.

**IMPORTANT** Unleaded petrol tends to create deposits in the container if stored for more than 2 months. Always use fresh petrol!

#### 7.2.2 Oil characteristics

Only use top quality synthetic oil that is specifically for two-stroke engines, of JASO FC minimum specification. Your dealer can provide you with oils which have been specifically developed for this type of engine, and which are capable of guaranteeing a high level of protection. The use of these oils makes it possible to prepare a 2.5% mixture, consisting of 1 part oil to 40 parts petrol.

#### 7.2.3 Preparation and storage of the fuel mixture

The chart indicates the amount of petrol and oil to use to prepare the fuel mixture.

| Petrol | 2-stroke synthetic oil |
|--------|------------------------|
| litres | litres                 |
| 1      | 0.025                  |
| 2      | 0.050                  |
| 3      | 0.075                  |

|    |       |
|----|-------|
| 5  | 0.125 |
| 10 | 0.250 |

To prepare the fuel mixture:

1. Place about half the amount of petrol in a homologated tank.
2. Add all the oil.
3. Add the rest of the petrol.
4. Close the top and shake well.

**IMPORTANT** *The fuel mixture tends to age. Do not prepare excessive amounts of the fuel mixture to avoid the formation of deposits.*

**IMPORTANT** *Keep the petrol and fuel mixture containers separate and easily identifiable to avoid the mistake of using one in place of the other.*

**IMPORTANT** *Periodically clean the petrol and fuel mixture containers to remove any deposits.*

### 7.3 REFUELLING

**⚠ Refuelling must take place when the machine is switched off and the spark plug cap removed.**

Before refuelling:

1. Shake the fuel mixture container well.
2. Place the machine on a flat stable surface, with the fuel tank cap facing upwards.

**NOTE** *The following symbol is found near the fuel tank cap (Fig.32.A):*



Fuel mixture tank

3. Clean the fuel tank cap and the surrounding area to prevent any dirt from entering the tank during refuelling.
4. Open the fuel tank cap carefully to allow the pressure inside to decrease gradually.
5. Use a funnel to refill and avoid filling the tank to the brim.

**NOTE** *When using the machine, the fuel level can be checked through the tank window (Fig. 32.B).*

### 7.4 TOPPING UP THE CHAIN OIL TANK

**NOTE** *The following symbol is found near the chain oil tank cap (Fig. 32.C):*



Chain oil tank

**IMPORTANT** *Only use chainsaw oil or adhesive oil for chainsaws. Do not use oil containing impurities so as not to block the oil filter and to prevent irreparable damage to the oil pump.*

It is essential that you use good quality oil to lubricate the cutting parts effectively. Used or poor quality oil does not guarantee good lubrication and reduces the working life of the chain and bar.

- It is always worth topping up the oil tank completely (using a funnel) every time you refuel. Since the oil tank capacity is enough to guarantee that the fuel runs out first, you will avoid the risk of operating the machine without lubricant.

### 7.5 CLEANING THE MACHINE AND THE ENGINE

After every work session, clean the machine thoroughly to remove all dust and debris.

- To reduce fire hazards:
  - keep the machine and, in particular, the engine and muffler zone free of sawdust, branches, leaves, or excessive grease;
  - use compressed air to clean the cylinder fins on a regular basis (Fig. 33).
- To avoid overheating and damage to the engine:
  - always keep the cooling air vent (Fig. 34) clean and free of sawdust and debris.
- Keep the clutch bell free of sawdust and debris (Fig. 35), removing the clutch (par. 4.2) and remounting it correctly afterwards. Have your dealer check the greasing of the internal bearing approximately every 30 hours.

### 7.6 CLEANING THE CHAIN

Remove any traces of sawdust or oil deposits from the chain every time it is used.

If there is excessive dirt or resin build-up, disassemble the chain and place it in a container with a specific cleanser for a few

hours. Then rinse with clean water and treat with a suitable anticorrosive spray, before reassembling on the machine.

## 7.7 CHAIN CATCHER

Before use, always check the condition of the chain catcher (Fig. 1.H) beforehand and replace it if damaged.

## 7.8 NUTS AND BOLTS

- Before use, always check that all nuts and bolts are securely tightened to be sure the machine is in safe working condition.
- Before use, always check that the hand grips are firmly fastened in place.

# 8. EXTRAORDINARY MAINTENANCE

## 8.1 MACHINE AND BAR LUBRICATION HOLES

Before daily use, remove the clutch casing (par. 4.2), remove the bar and check that neither the machine lubrication (Fig. 36.A) nor the guide bar (Fig. 36.B) holes are clogged.

## 8.2 CLEANING THE AIR FILTER

**IMPORTANT** *Cleaning the air filter is essential to guarantee the efficiency and durability of the machine. Do not work with a damaged filter or without a filter, as this could permanently damage the engine.*

It must be cleaned after every 8-10 working hours.

Clean the filter as follows:

1. Release the tab (Fig. 37.A) and remove the cover (Fig. 37.B).
2. Press the metal air filter block until it attaches with a click (Fig. 38.A).
3. Remove the air filter (Fig. 38.B), tap it gently to remove the dirt and clean using a soft brush.
4. If the filter is completely clogged, wash with clean petrol. If you are using compressed air, aim the jet so that it blows from the inside towards the outside (Fig. 39.A).
5. Replace the filter (Fig. 40.B), pull the metal block (Fig. 40.A) until it clicks the filter into position.
6. Remount the casing (Fig. 41.A) making sure that all the parts are

positioned correctly in their housings on the cylinder cover (Fig. 41.B).

7. Insert the lower section of the tab and press the top part until it clicks into place (Fig. 41.C).

## 8.3 CLUTCH HOUSING

Have your dealer check the condition of the metal band around the clutch housing once a month. The band must be replaced if deteriorated or deformed.

## 8.4 CHAIN DRIVE SPROCKET

Regularly check the condition of the sprocket with your local dealer or Authorised Service Centre and replace it when wear exceeds the accepted limits.

 **Do not mount a new chain with a worn sprocket or vice-versa.**

## 8.5 CHECKING THE SPARK PLUG

The spark plug (Fig. 31.A) can be accessed by removing the air filter cover (Fig. 37.B).

Periodically remove and clean the spark plug using a metal brush to get rid of any deposits (Fig. 42.A). Check and reset the correct distance between the electrodes (Fig. 42.B). Replace the spark plug and fasten it firmly using the supplied wrench. The spark plug must be replaced with one with the same characteristics whenever the electrodes have burnt or the insulation has worn, and in any case every 100 working hours.

## 8.6 STARTER CABLE

The starter rope must be replaced by your Dealer or Authorised Service Centre as soon as it shows signs of wear.

## 8.7 MAINTENANCE OF THE TOOTHED CHAIN

 **To ensure that the chainsaw works safely and efficiently, it is essential that the cutting means are well-sharpened.**

Chain sharpening is necessary when:

- the sawdust looks like dust.
- cutting becomes more difficult.

- the cut is not straight.
- vibrations increase.
- fuel consumption increases.

**⚠ Kickback may occur if the chain is not sufficiently sharpened**

**IMPORTANT** *It is recommended to have a specialised centre sharpen the chain using the right tools to ensure minimum removal of material and even sharpness on all the cutting edges.*

### 8.7.1 Chain sharpening

If you sharpen the chain yourself, use special round-section files with the right diameter depending on the type of chain (see "Chain Maintenance Table", chap. 14). You need a certain amount of skill and experience to avoid damaging the cutting edges.

Sharpen the chain as follows:

1. Stop the machine (par. 6.6).
2. Disengage the chain brake (par. 5.7).
3. Secure the bar with the chain in a vice (Fig. 43.A), so that the chain can run smoothly.
4. Tighten the chain if it is loose (par. 6.1.3).
5. Insert the file in the tooth at a constant angle from the cutting edge (Fig. 43.B). Using a sharpening plate makes using the file easier (Fig. 43.C).
6. Sharpen in a forward motion a few times and repeat this on all the cutting edges facing the same way (right or left).
7. Turn the bar over in the vice and repeat on all the other cutting edges.
8. Check that the limiter tooth (Fig. 43.D) complies with the levels indicated in the "Chain Maintenance Table" (chap. 14) and file any projecting parts with a flat file, rounding off the edge.
9. After sharpening, remove all traces of filing and dust and lubricate the chain in an oil bath.

### 8.7.2 Replacing the toothed chain

Replace the chain when:

- the length of the cutting edges reduces to 5 mm or less (Fig. 43.E);
- there is too much play between the links and the rivets.
- the cutting speed is too slow and the repeated sharpening does not improve the cutting speed. The chain is worn.

**IMPORTANT** *After replacing the chain, its tension level must be checked more frequently due to settling of the chain.*

## 8.8 GUIDE BAR MAINTENANCE

**NOTE** *Any work on the guide bar requires specific experience and special tools in order to achieve top workmanship standards; for safety purposes, we recommend you contact your dealer to ensure work is done correctly.*

To avoid asymmetrical wear on the bar, make sure it is turned over periodically.

To keep the bar in perfect working order, proceed as follows:

1. Grease the bearings on the nose sprocket (if present) with the syringe (not included).
2. Clean the bar groove with the scraper (not included) (Fig. 44.A);
3. Clean the lubrication holes (Fig. 44.B);
4. With a flat file (not included), remove burr from the edges and level off the guides.

### 8.8.1 Replacing the bar

Replace the bar whenever:

- the groove is not as deep as the height of the drive links (which must never touch the bottom);
- the inside of the guide is worn enough to make the chain lean to one side.

## 8.9 TUNING MINIMUM SPEED

**⚠** *If the cutting means moves when the engine is running idle, contact your dealer or Authorised Service Centre to have the engine adjusted correctly (par. 8.11).*

### 8.10 TUNING THE CARBURETTOR

The carburettor is tuned by the manufacturer to achieve maximum performance in all situations, with a minimum emission of toxic gas in compliance with the regulations in force.

In the event of poor performance, contact your Dealer or Authorised Service Centre for a check of the carburetion and engine.

Carburettor tuning:

- T** = minimum speed tuning
- L** = low speed mixture tuning
- H** = high speed mixture tuning

## 9. STORING THE MACHINE

**IMPORTANT** *The safety regulations to follow for putting into storage are described in paragraph 2.4. Strictly comply with these instructions to avoid serious risks or hazards.*

If you are not going to use the machine for a period of more than 2-3 months, we recommend you do a few things before putting it away. This will make it easier when you want to use the machine again and will also prevent permanent damage to the engine.

Before putting the machine away:

1. Unscrew the two clutch housing nuts, remove the housing and remove the chain and bar.
2. Empty the oil tank, fill with about 100-120 cc of specific liquid detergent and plug the cap.
3. Fit the guard back on without tightening the nuts.
4. Start the engine and keep it running until all detergent is used.
5. Start the engine and run it idle until it uses up all the fuel that is left in the tank and the carburettor.
6. Wait for the engine to cool.
7. Remove the spark plug.
8. Pour a teaspoon of (new) 2-stroke engine oil into the spark plug slot.
9. Pull the starter hand grip several times to deliver oil to the cylinder.
10. Replace the spark plug with the piston in the dead end upper position (visible from the spark plug slot when the piston is at maximum stroke).
11. Clean the machine thoroughly.
12. Check the machine for any damage. If necessary, contact the Authorised Service Centre.
13. Store the machine:
  - in a dry place
  - protected from inclement weather
  - with the bar cover guard fitted correctly
  - in a place where children cannot get to it
  - making sure that keys or tools used for maintenance are removed.

Before starting to use the machine again:

1. Remove the spark plug.
2. Pull the starter hand grip a few times to eliminate excess oil.
3. Check the spark plug (par. 8.5).
4. Arrange the machine (par. 4.2 chap. 6)

## 10. HANDLING AND TRANSPORTATION

When handling or transporting the machine, always:

- stop the machine (par. 6.6).
- wait until the chain is stationary.
- remove the spark plug cap (Fig. 31.A).
- mount the bar cover.
- only hold the machine using the hand grips and position the bar in the opposite direction to that used during operation.

When transporting the machine on a vehicle, always:

- position it so that it does not cause a hazard to anyone;
- fasten firmly to the means of transport using ropes or chains to prevent it from tipping over causing damage and fuel leaks.

## 11. ASSISTANCE AND REPAIRS

This manual provides all the necessary information to run the machine and for correct basic maintenance operations which can be performed by the user. Any regulations and maintenance operations not described herein must be carried out by your Dealer or Authorized Service Centre, which have the necessary knowledge and equipment to ensure that the work is carried out correctly, maintaining the correct degree of safety and the original operating conditions of the machine. Any operations performed in unauthorized centres or by unqualified persons will invalidate the Warranty and all obligations and responsibilities of the Manufacturer.

- Only authorized service centres or dealers can carry out guaranteed repairs and maintenance.
- The authorized service centres or dealers only use genuine spare parts. Genuine spare parts and attachments have been designed specifically for machines.
- Non-genuine spare parts and attachments are not approved. Use of non-genuine spare parts and attachments cause the warranty to be invalidated.
- It is advisable to send your machine once a year to an authorized service centre or dealer for servicing, assistance and safety device inspection.

## 12. WARRANTY COVERAGE

The warranty covers all material and manufacturing defects. The user must

follow all the instructions provided in the accompanying documentation.

The warranty does not cover

damages caused by:

- Failure to become familiar with the documentation accompanying the machine.
- Carelessness.
- Incorrect or prohibited use or assembly.
- Use of non-genuine spare parts.
- Use of attachments not supplied or approved by the manufacturer.

The warranty does not cover:

- Normal wear and tear of consumables, such as cutting means, safety bolts.
- Normal wear and tear.

The purchaser is protected by his or her own national legislation. The purchaser's rights under the national laws or his or her own country are not in any way restricted by this warranty.

### 13. MAINTENANCE TABLE

| Intervention                                | Frequency  |                           | Paragraph |
|---|------------|---------------------------|-----------|
|   | First time | An then after             |           |
| <b>MACHINE</b>                              |            |                           |           |
| Check all fasteners                         | -          | Before each use           | 7.8       |
| Safety checks/check controls                | -          | Before each use           | 6.2       |
| Check the chain catcher                     | -          | Before each use           | 7.7       |
| Check the machine and bar lubrication holes | -          | Before each daily use     | 8.1       |
| General cleaning and inspection             | -          | After each use            | 7.5       |
| Cleaning the chain                          | -          | After each use            | 7.6       |
| Clutch housing bearing greasing             | -          | 30 hours                  | 7.5 *     |
| Check the clutch housing                    | -          | Once a month              | 8.3 *     |
| Check the chain drive sprocket              | -          | Once a month              | 8.4 *     |
| Chain maintenance                           | -          | -                         | 8.7, 14   |
| Bar maintenance                             | -          | -                         | 8.8       |
| <b>ENGINE</b>                               |            |                           |           |
| Checking/topping up fuel level              | -          | Before each use           | 7.3.      |
| Topping up the chain oil level              | -          | Whenever refuelling       | 7.4.      |
| General cleaning and inspection             | -          | After each use            | 7.5       |
| Cleaning the air filter                     |            | 8-10 hours / every season | 8.2       |
| Cleaning the spark plug                     | -          | 10 hours / every season   | 8.5       |
| Replace spark plug                          | -          | 100 hours / every season  | 8.5       |

\* The operation must be carried out by your Dealer or a Authorised Service Centre

## 14. CHAIN MAINTENANCE TABLE

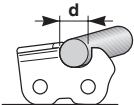
| Chain pitch     |       | Limiter tooth level (a)   |      | File diameter (d)   |     |
|-----------------|-------|---|------|---|-----|
|                 |       |  |      |  |     |
| inches          | mm    | inches  | mm   | inches  | mm  |
| <b>3/8 Mini</b> | 9.32  | 0.018   | 0.45 | 5/32  | 4.0 |
| <b>0.325</b>    | 8.25  | 0.026   | 0.65 | 3/16  | 4.8 |
| <b>3/8</b>      | 9.32  | 0.026   | 0.65 | 13/64   | 5.2 |
| <b>0.404</b>    | 10.26 | 0.031   | 0.80 | 7/32  | 5.6 |

**⚠** *This table gives the sharpening data for different types of chains, but this does not mean you can use chains other than*

*those approved and listed in the "Correct bar and chain combination table".*

## 15. PROBLEM IDENTIFICATION

| PROBLEM  | PROBABLE CAUSE  | REMEDY   |
|--|---|--|
| 1. The engine will not start or will not keep running      | Incorrect starting procedure.                                       | Follow the instructions (par. 6.3)   |
|  | Dirty spark plug or incorrect distance between the electrodes       | Check the spark plug (par. 8.5).   |
|  | Air filter clogged  | Clean and/or replace the filter (par. 8.2).  |
|  | Anti-freeze device assembled incorrectly                            | Check the assembly position (par. 6.1.4)   |
|  | Carburetion problems  | Contact the Authorised Service Centre or dealer..  |
| 2. The engine starts but lacks power.                      | Air filter clogged  | Clean and/or replace the filter (par. 8.2).  |
|  | Carburetion problems  | Contact the Authorised Service Centre or dealer.   |
| 3. The engine runs irregularly and lacks power when revved | Dirty spark plug or incorrect distance between the electrodes       | Check the spark plug (par. 8.5).   |
|  | Bar and chain problems  | Check that the chain runs freely and the bar guides are not deformed.  |
|  | Carburetion problems  | Contact the Authorised Service Centre or dealer.   |
| 4. The engine makes too much smoke                         | Incorrect composition of the fuel mixture                           | Prepare the fuel mixture according to the instructions (par. 7.2)  |
|  | Carburetion problems  | Contact the Authorised Service Centre or dealer.   |
| 5. If the engine floods                                    | The starter grip has been driven repeatedly with the choke engaged. | Remove the spark plug (par. 8.5) and gently pull the starter rope hand grip (Fig. 11.D) to eliminate any excess fuel; then dry the spark plug electrodes and remount it on the engine. |



| PROBLEM  | PROBABLE CAUSE                   | REMEDY   |
|--|----------------------------------|--|
| 6. No oil is released                              | Poor quality oil                 | When the engine is cold, empty the tank, clean it and the pipes with liquid detergent and change the oil.  |
|  | Lubrication holes are clogged    | Clean them (chap. 8.1)   |
| 7. The chain moves when the engine is running idle | Incorrect adjustment of fuelling | Contact the Authorised Service Centre or dealer.   |
| 8. The machine starts to vibrate abnormally        | Damaged or loose parts.          | Stop the machine and disconnect the spark plug cable (Fig. 31.A). Inspect for damage. Check and tighten any loose parts. Have all checks, repair work and replacements carried out by an Authorised Service Centre or dealer only. |
| 9. The machine has struck a foreign body.          | Damaged or loose parts.          | Stop the machine and disconnect the spark plug cable (Fig. 31.A). Inspect for damage. Check and tighten any loose parts. Have all checks, repair work and replacements carried out by an Authorised Service Centre or dealer only. |

If problems persist after having performed the above operations, contact your dealer or an Authorised Service Centre.

## 16. ACCESSORIES

The "Correct bar and chain combination table" contains a list of all possible combinations between bar and chain, indicating those which may be used on each machine, marked with the symbol "✓".

***of each bar or chain, contact your dealer or Authorised Service Centre.***

The same table also provides the specification data for all chains and bars approved for use on each machine.

***⚠ Only use the replacement bars and chains listed in the table. The use of unapproved combinations may be hazardous and cause serious injuries to operators and damage the machine.***

***⚠ In consideration that the selection, application and use of the bar and chain are actions made solely by the user, at his own discretion, the latter assumes responsibility for damages of any kind arising from such actions. When in doubt or if lacking knowledge of the specifics***

**DICHIARAZIONE CE DI CONFORMITÀ (Istruzioni Originali)**  
(Direttiva Macchine 2006/42/CE, Allegato II, parte A)

1. La Società: ST. S.p.A. – Via del Lavoro, 6 – 31033 Castelfranco Veneto (TV) – Italy

2. Dichiaro sotto la propria responsabilità, che la macchina:

Motosega a catena per lavori forestali (abbattimento, sezionamento, sramatura di alberi)

|                         |                                 |
|-------------------------|---------------------------------|
| a) Tipo / Modello Base: | SP 386 - SP 426                 |
| c) Numero di Serie:     | 22A••CHA000001 ÷ 99L••CHA999999 |
| d) Motore:              | a scoppio                       |

3. È conforme alle specifiche delle direttive:

• MD: 2006/42/EC

e) Ente Certificatore: N. 0905 – Intertek Deutschland GmbH  
Stangenstrasse 1, 70771 Leinfelden-Echterdingen - Germany

f) Esame CE del tipo: 16SHW0433-05

• OND: 2000/14/EC, ANNEX V - 2005/88/EC

D. Lgs.262/2002, ANNEX V (Italy)

• EMCD: 2014/30/EU

• RoHS II: 2011/65/EU - 2015/863/EU

4. Riferimento alle Norme armonizzate:

EN ISO 11681-1:2022

EN ISO 14982:2009

EN IEC 63000:2018

|   | <b>SP 386</b> | <b>SP 426</b> |
|---|---------------|---------------|
| g) Livello di potenza sonora misurato:  | 112 dB(A)     | 110 dB(A)     |
| h) Livello di potenza sonora garantito: | 115 dB(A)     | 114 dB(A)     |
| j) Potenza installata:                  | 1,6 kW        | 1,9 kW        |

n) Persona autorizzata a costituire il FascicoloTecnico: ST. S.p.A.  
Via del Lavoro, 6  
31033 Castelfranco Veneto (TV) - Italia

o) Castelfranco Veneto, 01/10/2022

CEO Stiga Group

Sean Robinson

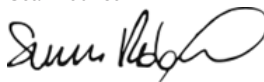

## UK DECLARATION OF CONFORMITY

(Supply of Machinery (Safety) Regulations 2008, S.I. 2008 No. 1597, Annex II, part A)

1. The company: ST. S.p.A. – Via del Lavoro, 6 – 31033 Castelfranco Veneto (TV) – Italy

2. Hereby declares under its own responsibility that the machine (function):

Chainsaw for forest service (felling, bucking, delimiting trees)

|                       |                                 |
|-----------------------|---------------------------------|
| a) Homologation type: | SP 386 - SP 426                 |
| c) Serial number:     | 22A**CHA000001 ÷ 99L**CHA999999 |
| d) Engine:            | petrol                          |

3. Conforms to UK Regulations:

- S.I. 2008/1597 - Supply of Machinery (Safety) Regulations 2008

e) Notified body: N. 0905 – Intertek Deutschland GmbH  
Stangenstrasse 1, 70771 Leinfelden-Echterdingen - Germany

f) EC type-examination: 16SHW0433-05

- S.I. 2001/1701 - Schedule 8 - Noise Emission in the Environment by Equipment for use Outdoors Regulations 2001
- S.I. 2016/1091 - Electromagnetic Compatibility Regulations 2016
- S.I. 2012/3032 - The Restriction of the Use of Certain Hazardous Substances in Electrical and Electronic Equipment Regulations 2012

4. Reference to harmonised standards:

EN ISO 11681-1:2022

EN ISO 14982:2009

EN IEC 63000:2018

### SP 386

### SP 426

|                                  |           |           |
|----------------------------------|-----------|-----------|
| g) Measured sound power level:   | 112 dB(A) | 110 dB(A) |
| h) Guaranteed sound power level: | 115 dB(A) | 114 dB(A) |
| j) Net power installed:          | 1,6 kW    | 1,9 kW    |

n) Person authorised to compile the technical file: ST. S.p.A.  
Via del Lavoro, 6  
31033 Castelfranco Veneto (TV) - Italia

o) Castelfranco Veneto, 01/10/2022

CEO Stiga Group

Sean Robinson

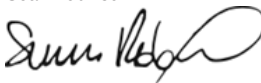

UK Importer: STIGA LTD  
Unit 8, Bluewater Estate Plympton,  
Devon, PL7 4JH, England



**DICHIARAZIONE CE DI CONFORMITÀ (Istruzioni Originali)**  
(Direttiva Macchine 2006/42/CE, Allegato II, parte A)

1. La Società: ST. S.p.A. – Via del Lavoro, 6 – 31033 Castelfranco Veneto (TV) – Italy

2. Dichiaro sotto la propria responsabilità, che la macchina:

Motosega a catena per lavori forestali (abbattimento, sezionamento, sramatura di alberi)

|                         |                                 |
|-------------------------|---------------------------------|
| a) Tipo / Modello Base: | SP 466 - SP 526                 |
| c) Numero di Serie:     | 22A••CHA000001 ÷ 99L••CHA999999 |
| d) Motore:              | a scoppio                       |

3. È conforme alle specifiche delle direttive:

• MD: 2006/42/EC

e) Ente Certificatore: N. 0905 – Intertek Deutschland GmbH  
Stangenstrasse 1, 70771 Leinfelden-Echterdingen - Germany

f) Esame CE del tipo: 16SHW0499-04

• OND: 2000/14/EC, ANNEX V - 2005/88/EC

D. Lgs.262/2002, ANNEX V (Italy)

• EMCD: 2014/30/EU

• RoHS II: 2011/65/EU - 2015/863/EU

4. Riferimento alle Norme armonizzate:

EN ISO 11681-1:2022

EN ISO 14982:2009

EN IEC 63000:2018

|   | <b>SP 466</b> | <b>SP 526</b> |
|---|---------------|---------------|
| g) Livello di potenza sonora misurato:  | 112 dB(A)     | 111 dB(A)     |
| h) Livello di potenza sonora garantito: | 115 dB(A)     | 114 dB(A)     |
| j) Potenza installata:                  | 2,0 kW        | 2,3 kW        |

n) Persona autorizzata a costituire il FascicoloTecnico: ST. S.p.A.  
Via del Lavoro, 6  
31033 Castelfranco Veneto (TV) - Italia

o) Castelfranco Veneto, 01/10/2022

CEO Stiga Group

Sean Robinson

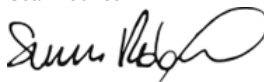

## UK DECLARATION OF CONFORMITY

(Supply of Machinery (Safety) Regulations 2008, S.I. 2008 No. 1597, Annex II, part A)

1. The company: ST. S.p.A. – Via del Lavoro, 6 – 31033 Castelfranco Veneto (TV) – Italy
2. Hereby declares under its own responsibility that the machine (function):  
Chainsaw for forest service (felling, bucking, delimiting trees)

|                       |                                 |
|-----------------------|---------------------------------|
| a) Homologation type: | SP 466 - SP 526                 |
| c) Serial number:     | 22A**CHA000001 ÷ 99L**CHA999999 |
| d) Engine:            | petrol                          |

### 3. Conforms to UK Regulations:

- S.I. 2008/1597 - Supply of Machinery (Safety) Regulations 2008
  - e) Notified body: N. 0905 – Intertek Deutschland GmbH  
Stangenstrasse 1, 70771 Leinfelden-Echterdingen - Germany
  - f) EC type-examination: 16SHW0499-04
- S.I. 2001/1701 - Schedule 8 - Noise Emission in the Environment by Equipment for use Outdoors Regulations 2001
- S.I. 2016/1091 - Electromagnetic Compatibility Regulations 2016
- S.I. 2012/3032 - The Restriction of the Use of Certain Hazardous Substances in Electrical and Electronic Equipment Regulations 2012

### 4. Reference to harmonised standards:

EN ISO 11681-1:2022  
EN ISO 14982:2009  
EN IEC 63000:2018

|                                  | SP 466    | SP 526    |
|----------------------------------|-----------|-----------|
| g) Measured sound power level:   | 112 dB(A) | 111 dB(A) |
| h) Guaranteed sound power level: | 115 dB(A) | 114 dB(A) |
| j) Net power installed:          | 2,0 kW    | 2,3 kW    |

n) Person authorised to compile the technical file: ST. S.p.A.  
Via del Lavoro, 6  
31033 Castelfranco Veneto (TV) - Italia

o) Castelfranco Veneto, 01/10/2022

CEO Stiga Group  
Sean Robinson



UK Importer: STIGA LTD  
Unit 8, Bluewater Estate Plympton,  
Devon, PL7 4JH, England



|   |   |  |
|---|---|--|
| <p>FR (Traduction de la notice originale)</p> <p><b>Déclaration CE de Conformité</b><br/>(Directive Machines 2006/42/CE, Annexe II, partie A)</p> <ol style="list-style-type: none"> <li>La Société</li> <li>Déclare sous sa propre responsabilité que la machine : Scie à chaîne pour travaux forestiers abattage/tronçonnage/ébranchage d'arbres</li> <li> <ol style="list-style-type: none"> <li>Type / Modèle de Base</li> <li>Mois / Année de construction</li> <li>Série</li> <li>Moteur: moteur essence</li> </ol> </li> <li>Est conforme aux prescriptions des directives : <ol style="list-style-type: none"> <li>Organisme de certification</li> <li>Examen CE du Type</li> </ol> </li> <li>Renvoi aux Normes harmonisées</li> <li>Niveau de puissance sonore mesuré</li> <li>Niveau de puissance sonore garanti</li> <li>Puissance nette installée</li> <li>Personne habilitée à établir le Dossier Technique :</li> <li>Lieu et Date</li> </ol>                               | <p>EN (Translation of the original instruction)</p> <p><b>EC Declaration of Conformity</b><br/>(Machine Directive 2006/42/EC, Annex II, part A)</p> <ol style="list-style-type: none"> <li>The Company</li> <li>Herby declares under its own responsibility that the machine: Chainsaw for forest service felling, bucking, delimiting trees</li> <li> <ol style="list-style-type: none"> <li>Type / Base Model</li> <li>Month / Year of manufacture</li> <li>Serial number</li> <li>Engine: petrol</li> </ol> </li> <li>Conforms to directive specifications: <ol style="list-style-type: none"> <li>Certifying body</li> <li>EC examination of Type</li> <li>Reference to harmonised Standards</li> <li>Sound power level measured</li> <li>Sound power level guaranteed</li> <li>Net power installed</li> <li>Person authorised to create the Technical Folder:</li> <li>Place and Date</li> </ol> </li> </ol>                                       | <p>DE (Übersetzung der Originalbetriebsanleitung)</p> <p><b>EG-Konformitätserklärung</b><br/>(Maschinenrichtlinie 2006/42/EG, Anhang II, Teil A)</p> <ol style="list-style-type: none"> <li>Die Gesellschaft</li> <li>Erklärt auf eigene Verantwortung, dass die Maschine: Kettensäge für die Forstarbeit</li> <li> <ol style="list-style-type: none"> <li>Typ / Basismodell</li> <li>Monat / Baujahr</li> <li>Seriennummer</li> <li>Motor: Verbrennungsmotor</li> </ol> </li> <li>Den Anforderungen der folgenden Richtlinien entspricht: <ol style="list-style-type: none"> <li>Zertifizierungsstelle</li> <li>EG-Baumusterprüfung</li> <li>Bezugnahme auf die harmonisierten Normen</li> <li>Gemessener Schalleistungspegel</li> <li>Garantierter Schalleistungspegel</li> <li>Installierte Nettoleistung</li> <li>Nur Verfassung der technischen Unterlagen befugte Person:</li> <li>Ort und Datum</li> </ol> </li> </ol>                  |
| <p>NL (Vertaling van de oorspronkelijke gebruiksaanwijzing)</p> <p><b>EG-verklaring van overeenstemming</b><br/>(Richtlijn Machines 2006/42/CE, Bijlage II, deel A)</p> <ol style="list-style-type: none"> <li>Het bedrijf</li> <li>Verklaart onder zijn eigen verantwoordelijkheid dat de machine: Kettingzaag voor boswerken vellen/snijden/snoeien van bomen</li> <li> <ol style="list-style-type: none"> <li>Type / Basismodel</li> <li>Maand / Bouwjaar</li> <li>Serienummer</li> <li>Motor: accu</li> </ol> </li> <li>Voldoet aan de specificaties van de richtlijnen: <ol style="list-style-type: none"> <li>Certificatie-instituut</li> <li>EG-onderzoek van het Type</li> </ol> </li> <li>Verwijzing naar de Geharmoniseerde normen</li> <li>Gemeten niveau van geluidsvermogen</li> <li>Gegarandeerd niveau van geluidsvermogen</li> <li>Netto geïnstalleerd vermogen</li> <li>Bevoegd persoon voor het opstellen van het Technisch Dossier</li> <li>Plaats en Datum</li> </ol> | <p>ES (Traducción del Manual Original)</p> <p><b>Declaración de Conformidad CE</b><br/>(Directiva Máquinas 2006/42/CE, Anexo II, parte A)</p> <ol style="list-style-type: none"> <li>La Empresa</li> <li>Declara bajo su propia responsabilidad que la máquina: Motosierra de cadena para trabajos forestales tala/seccionamiento/poda de árboles</li> <li> <ol style="list-style-type: none"> <li>Tipo / Modelo Base</li> <li>Mes / Año de fabricación</li> <li>Matrícula</li> <li>Motor: motor de explosión</li> </ol> </li> <li>Cumple con las especificaciones de las directivas: <ol style="list-style-type: none"> <li>Ente certificador</li> <li>Examen CE del Tipo</li> </ol> </li> <li>Referencia a las Normas armonizadas</li> <li>Nivel de potencia sonora medido</li> <li>Nivel de potencia sonora garantizado</li> <li>Potencia neta instalada</li> <li>Persona autorizada a realizar el Manual Técnico:</li> <li>Lugar y Fecha</li> </ol> | <p>PT (Tradução do manual original)</p> <p><b>Declaração CE de Conformidade</b><br/>(Diretiva de Máquinas 2006/42/CE, Anexo II, parte A)</p> <ol style="list-style-type: none"> <li>A Empresa</li> <li>Declara so Motoserra para trabalhos florestais abate/seccionamento/desramação b a própria responsabilidade que a máquina:</li> <li> <ol style="list-style-type: none"> <li>Tipo / Modelo Base</li> <li>Mês / Ano de fabrico</li> <li>Matrícula</li> <li>Motor: motor a explosão</li> </ol> </li> <li>É conforme às especificações das diretivas: <ol style="list-style-type: none"> <li>Órgão certificador</li> <li>Exame CE do Tipo</li> </ol> </li> <li>Referência às Normas harmonizadas</li> <li>Nível medido de potência sonora</li> <li>Nível garantido de potência sonora</li> <li>Potência líquida instalada</li> <li>Pessoa autorizada a elaborar o Caderno Técnico</li> <li>Local e Data</li> </ol>                           |
| <p>EL (Μετάφραση του πρωτοτύπου των οδηγιών χρήσης)</p> <p><b>ΕΚ-Δήλωση συμμόρφωσης</b><br/>(Οδηγία Μηχανών 2006/42/CE, Παράρτημα II, μέρος Α)</p> <ol style="list-style-type: none"> <li>Η Εταιρία</li> <li>Δηλώνει υπεύθυνα ότι η μηχανή: Αλυσοπίοονο για δασικές εργασίες Κατάρτιση/κατατομή/κοπή κλαδιών δέντρων</li> <li> <ol style="list-style-type: none"> <li>Τύπος / Βασικό Μοντέλο</li> <li>Μήνας / Έτος κατασκευής</li> <li>Αριθμός μητρώου</li> <li>Κινητήρας: κινητήρας εσωτερικής ανάφλεξης</li> </ol> </li> <li>Συμμορφώνεται με τις προδιαγραφές της οδηγίας: <ol style="list-style-type: none"> <li>Οργανισμός πιστοποίησης</li> <li>Εξέταση CE του Τύπου</li> </ol> </li> <li>Αναφορά στους Κανονισμούς εναρμόσισης</li> <li>Στάθμη μέτρησης ακουστικής ισχύος</li> <li>Στάθμη εγγυημένης ακουστικής ισχύος</li> <li>Καθαρή εγκαταστημένη ισχύς</li> <li>Εξουσιοδοτημένο άτομο για την κατάρτιση του Τεχνικού Φυλλαδίου:</li> <li>Τόπος και Χρόνος</li> </ol>           | <p>TR (Orijinal Talimatların Tercümesi)</p> <p><b>AT Uygunluk Beyanı</b><br/>(2006/42/CE Makine Direktifi, Ek II, bölüm A)</p> <ol style="list-style-type: none"> <li>Şirket</li> <li>Şahsi sorumluluğu altında aşağıdaki makinenin: Orman işleri için zincirli testere</li> <li>Ağaçların kesilip devrilmesi/parçaları bölünmesi/dallarının budanması</li> <li> <ol style="list-style-type: none"> <li>Tip / Standart model</li> <li>Üretim Ay / yıl</li> <li>Sicil numarası</li> <li>Motor: patlamalı motor</li> </ol> </li> <li>Aşağıdaki direktiflerin özelliklerine uygun olduğunu beyan etmektedir: <ol style="list-style-type: none"> <li>Sertifikalendirilme kurumu</li> <li>Tipi CE inceleme</li> <li>Harmonize standartlara atf</li> <li>Ölçülen ses gücü seviyesi</li> <li>Garanti edilen ses gücü seviyesi</li> <li>Kurulu net güç</li> <li>Teknik Dosyayı oluşturmaya yetkili kişi:</li> <li>Yer ve Tarih</li> </ol> </li> </ol>           | <p>МК (Превод на оригиналните упатства)</p> <p><b>Декларација за усогласеност со ЕУ</b><br/>(Директива за машини 2006/42/CE, Анекс II, дел А)</p> <ol style="list-style-type: none"> <li>Компанијата</li> <li>изјавува со целосна лична одговорност дека следната машина: Моторна пила со синџир за работа во шума</li> <li>Соборување/сечење/кастрене на дрва</li> <li>Тип / основен модел</li> <li>Месец / Година на производство</li> <li>в етикета</li> <li>мотор: мотор со согорување</li> <li>Усогласено со спецификациите според директивите: <ol style="list-style-type: none"> <li>тело за сертификација</li> <li>тест CE за типот</li> </ol> </li> <li>Референци на усогласени нормативи</li> <li>Акустички притисок</li> <li>измерено ниво на звучна моќност</li> <li>Ниво на гарантирана звучна моќност</li> <li>вибрации на рацете</li> <li>овластено лице за составување на Техничката брошура</li> <li>место и датум</li> </ol> |

|  |  |   |
|--|--|---|
| <p><b>NO</b> (Oversættelse av original bruksanvisning)</p> <p><b>EF- Samsvarserklæring</b><br/>(Maskindirektiv 2006/42/EF, Vedlegg II, del A)</p> <ol style="list-style-type: none"> <li>1. Firmaet</li> <li>2. Erklærer på eget ansvar at maskinen: Kjedesag for vanlig skogbruk</li> <li>Nedfelling/kutt/visting av trær</li> <li>a) Type / Modell</li> <li>b) Måned / Byggeår</li> <li>c) Serienummer</li> <li>d) Motor: forbrenningsmotor</li> <li>3. Oppfyller kravene i direktivene:</li> <li>e) Sertifiseringsorgan</li> <li>f) EF-typeprøving</li> <li>4. Henvisning til harmoniserte standarder</li> <li>g) Målt lydeffektivnivå</li> <li>h) Garantert lydeffektivnivå</li> <li>j) Installert nettoeffekt</li> <li>n) Person som har fullmakt til å utferdige teknisk dokumentasjon:</li> <li>o) Sted og dato</li> </ol>  | <p><b>SV</b> (Översättning av bruksanvisning i original)</p> <p><b>EG-försäkran om överensstämmelse</b><br/>(Maskindirektiv 2006/42/EG, bilaga II, del A)</p> <ol style="list-style-type: none"> <li>1. Företaget</li> <li>2. Försäkrar på eget ansvar att maskinen : Kedjesåg för skogsarbete</li> <li>Fällning/kapning/grenklippning av träd</li> <li>a) Typ / Basmodell</li> <li>b) Månad / Tillverkningsår</li> <li>c) Serienummer</li> <li>d) Motor: förbränningsmotor</li> <li>3. Överensstämmer med föreskrifterna i direktivet</li> <li>e) Intygsorgan_ Anmält organ</li> <li>f) EG typgodkännande</li> <li>4. Referens till harmoniserade standarder</li> <li>g) Uppmått ljudeffektivnivå</li> <li>h) Garanterad ljudeffektivnivå</li> <li>j) Installerad nettoeffekt</li> <li>n) Auktoriserad person för upprättandet av den tekniska dokumentationen:</li> <li>o) Ort och datum</li> </ol>        | <p><b>DA</b> (Oversættelse af den originale bruksanvisning)</p> <p><b>EF-overensstemmelseserklæring</b><br/>(Maskindirektiv 2006/42/EF, bilag II, del A)</p> <ol style="list-style-type: none"> <li>1. Firmaet</li> <li>2. Erklærer på eget ansvar, at maskinen: Kædesav til skovarbejde</li> <li>Fældning af træer/udskæring af stykker/opskæring af grene</li> <li>a) Type / Model</li> <li>b) Måned / Konstruktionsår</li> <li>c) Serienummer</li> <li>d) Motor: forbrændingsmotor</li> <li>3. Er i overensstemmelse med specifikationerne ifølge direktiverne:</li> <li>e) Certificeringsorgan</li> <li>f) EF-typeafprøving</li> <li>4. Henvisning til harmoniserede standarder</li> <li>g) Målt lydeffektivniveau</li> <li>h) Garanteret lydeffektivniveau</li> <li>j) Installeret nettoeffekt</li> <li>n) Person, der har bemyndigelse til at udarbejde det tekniske dossier:</li> <li>o) Sted og dato</li> </ol>                               |
| <p><b>FI</b> (Alkuperäisten ohjeiden käännö)</p> <p><b>EY-VAATIMUSTENMUKAISUUSVAKUUTUS</b><br/>(Konedirektiivi 2006/42/EY, Liite II, osa A)</p> <ol style="list-style-type: none"> <li>1. Yritys</li> <li>2. Vakuuttaa omalla vastuullaan, että kone: Moottorisaha metsänhoitoon</li> <li>Puiden kaataminen/piikkominen/karsinta</li> <li>a) Tyyppi / Perusmalli</li> <li>b) Kuukausi /Valmistusvuosi</li> <li>c) Sarjanumero</li> <li>d) Moottori : räjähdysmoottori</li> <li>3. On yhdenmukainen seuraavien direktiivien asettamien vaatimusten kanssa:</li> <li>e) Sertifiointiyritys</li> <li>f) EY-tyyppitarkastus</li> <li>4. Viittaus harmonisoituihin standardeihin</li> <li>g) Mitattu äänitehotaso</li> <li>h) Taattu äänitehotaso</li> <li>j) Asennettu nettoteho</li> <li>n) Teknisten asiakirjojen laatimiseen valtuutettu henkilö:</li> <li>o) Paikka ja päivämäärä</li> </ol>                 | <p><b>CS</b> (Překlad původního návodu k používání)</p> <p><b>ES – Prohlášení o shodě</b><br/>(Směrnice o Strojních zařízeních 2006/42/ES, Příloha II, část A)</p> <ol style="list-style-type: none"> <li>1. Společnost</li> <li>2. Prohlašuje na vlastní odpovědnost, že stroj: Řetězová motorová pila pro lesnické práce</li> <li>Kácení/rozřezávání/odvčtování stromů</li> <li>a) Typ / Základní model</li> <li>b) Měsíc / Rok výroby</li> <li>c) Výrobní číslo</li> <li>d) Motor: spalovací motor</li> <li>3. Je ve shodě s nařízením o směrnici:</li> <li>e) Certifikační orgán</li> <li>f) ES zkouška Typu</li> <li>4. Odkazy na Harmonizované normy</li> <li>g) Naměřená úroveň akustického výkonu</li> <li>h) Zaručená úroveň akustického výkonu</li> <li>j) Čistý instalovaný výkon</li> <li>n) Osoba autorizovaná pro vytvoření Technického spisu:</li> <li>o) Místo a Datum</li> </ol>            | <p><b>PL</b> (Tłumaczenie instrukcji oryginalnej)</p> <p><b>Deklaracja zgodności WE</b><br/>(Dyrektywa maszynowa 2006/42/WE, Załącznik II, część A)</p> <ol style="list-style-type: none"> <li>1. Spółka</li> <li>2. Oświadcza na własną odpowiedzialność, że maszyna: Pilarka łańcuchowa do prac leśnych</li> <li>Ścinanie, obalanie/przerzanie/okresywanie drzew</li> <li>a) Typ / Model podstawowy</li> <li>b) Miesiąc / Rok produkcji</li> <li>c) Numer seryjny</li> <li>d) Silnik: silnik o zaplonie iskrowym</li> <li>3. Spełnia podstawowe wymogi następujących Dyrektyw:</li> <li>e) Jednostka certyfikująca</li> <li>f) Badanie typu WE</li> <li>4. Odniesienie do Norm zharmonizowanych</li> <li>g) Zmierzony poziom mocy akustycznej</li> <li>h) Gwarantowany poziom mocy akustycznej</li> <li>j) Moc zainstalowana netto</li> <li>n) Osoba upoważniona do zredagowania Dokumentacji technicznej:</li> <li>o) Miejsowość i data</li> </ol> |
| <p><b>HU</b> (Eredeti használati utasítás fordítása)</p> <p><b>EK-megfelelőségi nyilatkozata</b><br/>(2006/42/EK gépirányelv, II. melléklet "A" rész)</p> <ol style="list-style-type: none"> <li>1. Alulírott Vállalat</li> <li>2. Felelőségének teljes tudatában kijelenti, hogy az alábbi gép: Erdészeti motoros láncfűrész</li> <li>Fák kidöntése/darabolása/gallyazása</li> <li>a) Típus / Alaptípus</li> <li>b) Hónap / Gyártás éve</li> <li>c) Gyártási szám</li> <li>d) Motor: robbanómotor</li> <li>3. Megfelel az alábbi irányelvek előírásainak:</li> <li>e) Tanúsító szerv</li> <li>f) CE vizsgálat típusa</li> <li>4. Hivatkozás a harmonizált szabványokra</li> <li>g) Mért zajteljesítmény szint</li> <li>h) Garantált zajteljesítmény szint</li> <li>j) Nettó beépített teljesítmény</li> <li>n) Műszaki Dosszié szerkesztésére felhatalmazott személy:</li> <li>o) Helye és ideje</li> </ol> | <p><b>HU</b> (Eredeti használati utasítás fordítása)</p> <p><b>EK-megfelelőségi nyilatkozata</b><br/>(2006/42/EK gépirányelv, II. melléklet "A" rész)</p> <ol style="list-style-type: none"> <li>1. Alulírott Vállalat</li> <li>2. Felelőségének teljes tudatában kijelenti, hogy az alábbi gép: Erdészeti motoros láncfűrész</li> <li>Fák kidöntése/darabolása/gallyazása</li> <li>a) Típus / Alaptípus</li> <li>b) Hónap / Gyártás éve</li> <li>c) Gyártási szám</li> <li>d) Motor: robbanómotor</li> <li>3. Megfelel az alábbi irányelvek előírásainak:</li> <li>e) Tanúsító szerv</li> <li>f) CE vizsgálat típusa</li> <li>4. Hivatkozás a harmonizált szabványokra</li> <li>g) Mért zajteljesítmény szint</li> <li>h) Garantált zajteljesítmény szint</li> <li>j) Nettó beépített teljesítmény</li> <li>n) Műszaki Dosszié szerkesztésére felhatalmazott személy:</li> <li>o) Helye és ideje</li> </ol> | <p><b>HR</b> (Prijevod originalnih uputa)</p> <p><b>EK Izjava o sukladnosti</b><br/>(Direktiva 2006/42/EZ o strojevima, dodatak II, dio A)</p> <ol style="list-style-type: none"> <li>1. Tvrtka:</li> <li>2. pod vlastitom odgovornošću izjavljuje da je stroj: Motorna lančana pila za šumarstvo</li> <li>Obaranje/prezivanje/obrezivanje stabala</li> <li>a) Vrsta / Osnovni model</li> <li>b) Mjesec / Godina proizvodnje</li> <li>c) Matični broj</li> <li>d) Motor: motor s unutarnjim izgaranjem</li> <li>3. sukladna s temeljnim zahtjevima direktiva:</li> <li>e) Certifikacijsko tijelo</li> <li>f) Tipsko ispitivanje EZ</li> <li>4. Primijenjene su sljedeće harmonizirane norme:</li> <li>g) Izmjerena razina zvučne snage</li> <li>h) Zajamčena razina zvučne snage</li> <li>j) Neto instalirana snaga</li> <li>n) Osoba ovlaštena za pravljenje Tehničke datoteke:</li> <li>o) Mjesto i datum</li> </ol>                                |

|  |  |   |
|--|--|---|
| <p>SL (Prevod izvirnih navodil)</p> <p>ES izjava o skladnosti (Direktiva 2006/42/ES), priloga II, del A)</p> <ol style="list-style-type: none"> <li>1. Družba</li> <li>2. pod lastno odgovornostjo izjavlja, da je stroj: Verižna žaga za gozdna dela, Podiranje/rezanje/odstranjevanje vej</li> <li>a) Tip / osnovni model</li> <li>b) Mesec /Leto izdelave</li> <li>c) Serijska številka</li> <li>d) Motor: motor z notranjim izgorevanjem</li> <li>3. Skladen je z določili direktiv :       <ol style="list-style-type: none"> <li>a) Ustanova, ki izda potrdilo</li> <li>f) ES pregled tipa</li> <li>4. Sklicevanje na usklajene predpise</li> <li>g) Izmerjen nivo zvočne moči</li> <li>h) Zagotovljen nivo zvočne moči</li> <li>j) Neto instalirana moč</li> <li>n) Oseba, pooblaščenca za sestavo tehnične knjižice:</li> <li>o) Kraj in datum</li> </ol> </li> </ol>  | <p>BS (Prijevod originalnih uputa)</p> <p>EZ izjava o skladnosti (Direktiva o mašinama 2006/42/EZ, Prilog II, deo A)</p> <ol style="list-style-type: none"> <li>1. Firma</li> <li>2. Daje izjavu pod vlastitom odgovornošću da je mašina: Lančana motorna pila za šumarstvo</li> <li>Obaranje i sječa drveća/rezanje grana</li> <li>a) Tip / Osnovni model</li> <li>b) Mjesec / Godina proizvodnje</li> <li>c) Serijski broj</li> <li>d) Motor: motor s unutrašnjim izgaranjem</li> <li>3. sukladna s osnovnim zahtjevima direktive:       <ol style="list-style-type: none"> <li>e) Certifikaciono tijelo</li> <li>f) EZ ispitivanje tipa</li> <li>4. Pozivanje na usklađene norme</li> <li>g) Izmjereni nivo zvučne snage</li> <li>h) Garantovani nivo zvučne snage</li> <li>j) Neto instalirana snaga</li> <li>n) Osoba ovlaštena za izradu tehničke brošure:           <ol style="list-style-type: none"> <li>o) Mjesto i datum</li> </ol> </li> </ol> </li> </ol>   | <p>SK (Preklad pôvodného návodu na použitie)</p> <p>ES vyhlásenie o zhode (Smernica o Strojnych zariadeniach 2006/42/ES, Priloha II, časť A)</p> <ol style="list-style-type: none"> <li>1. Spoločnosť</li> <li>2. Vyhlasuje na vlastnú zodpovednosť, že stroj: Reťazová motorová pila pre lesnícke práce, Stínanie/rozrezávanie/odvetovanie stromov</li> <li>a) Typ / Základný model</li> <li>b) Mesiac / Rok výroby</li> <li>c) Výrobné číslo</li> <li>d) Motor: spaľovací motor</li> <li>3. Je v zhode s nariadeniami smerníc:       <ol style="list-style-type: none"> <li>e) Certifikačný orgán</li> <li>f) Skúška typu ES</li> <li>4. Odkaz na Harmonizované normy</li> <li>g) Nameraná úroveň akustického výkonu</li> <li>h) Zaručená úroveň akustického výkonu</li> <li>j) Čistý inštalovaný výkon</li> <li>n) Osoba autorizovaná na vytvorenie Technického spisu:           <ol style="list-style-type: none"> <li>o) Miesto a Dátum</li> </ol> </li> </ol> </li> </ol>                                       |
| <p>RO (Traducerea manualului fabricantului)</p> <p>CE -Declaratie de Conformitate (Directiva Maşini 2006/42/CE, Anexa II, partea A)</p> <ol style="list-style-type: none"> <li>1. Societatea</li> <li>2. Declară pe propria răspundere că maşina: Ferăstrău cu lanţ pentru lucrări forestiere Doborâre/secţionare/tăierea ramurilor de copaci</li> <li>a) Tip / Model de bază</li> <li>b) Luna /Anul de fabricaţie</li> <li>c) Număr de serie</li> <li>d) Motor: motor cu combustie</li> <li>3. Este în conformitate cu specificaţiile directivelor:       <ol style="list-style-type: none"> <li>e) Organism de certificare</li> <li>f) Examinare CE de Tip</li> <li>4. Referinţă la Standardele armonizate</li> <li>g) Nivel de putere sonoră măsurat</li> <li>h) Nivel de putere sonoră garantat</li> <li>j) Putere netă instalată</li> <li>n) Persoană autorizată să întocmească Dosarul Tehnic</li> <li>o) Locul şi Data</li> </ol> </li> </ol>   | <p>LT (Originalių instrukcijų vertimas)</p> <p>EB atitikties deklaracija (Mašinių direktyva 2006/42/CE, Priedas II, dalis A)</p> <ol style="list-style-type: none"> <li>1. Bendrovė</li> <li>2. Prisiima atsakomybę, kad įrenginys: Grandininis pjūklas miško darbamsMedžių kirtimas/pjaustymas/genėjimas</li> <li>a) Tipas / Bazinis Modelis</li> <li>b) Mėnuo / Pagaminimo metai</li> <li>c) Serijos numeris</li> <li>d) Variklis: vidaus degimo variklis</li> <li>3. Atitinka direktyvoje pateiktas specifikacijas:       <ol style="list-style-type: none"> <li>e) Sertifikavimo įstaiga</li> <li>f) CE tipo tyrimas</li> <li>4. Nuoroda į suderintas Normas</li> <li>g) Išmatuotas garso galios lygis</li> <li>h) Užtikrinamas garso galios lygis</li> <li>j) Instaliuota naudingoji galia</li> <li>n) Autorizuotas asmuo sudaryti Techninę Dokumentaciją:           <ol style="list-style-type: none"> <li>o) Vieta ir Data</li> </ol> </li> </ol> </li> </ol>   | <p>LV (Instrukciju tulkojums no oriģinālvalodas)</p> <p>EK atbilstības deklarācija (Direktīva 2006/42/EK par mašīnām, pielikums II, daļa A)</p> <ol style="list-style-type: none"> <li>1. Uzņēmums</li> <li>2. Uzņemties par to pilnu atbildību, paziņo, ka mašīna: Grandininis pjūklas miško darbams</li> <li>Koku gāšana/zāģēšana/atzarošana</li> <li>a) Tips / Bāzes modelis</li> <li>b) Mēnesis / Ražošanas gads</li> <li>c) Sērijas numurs</li> <li>d) Motors: iekšdedzes motors</li> <li>3. Atbilst šādu direktīvu prasībām:       <ol style="list-style-type: none"> <li>e) Sertifikācijas iestāde</li> <li>f) CE tipveida pārbaude</li> <li>4. Atsauc uz harmonizētiem standartiem</li> <li>g) Izmērītais skaņas intensitātes līmenis</li> <li>h) Garantētais skaņas intensitātes līmenis</li> <li>j) Uzstādītā neto jauda</li> <li>n) Pilnvarotais darbinieks, kas sagatavoja tehnisko dokumentāciju:           <ol style="list-style-type: none"> <li>o) Vieta un datums</li> </ol> </li> </ol> </li> </ol> |
| <p>SR (Prevod originalnih uputstval)</p> <p>EC deklaracija o usaglašenosti (Direktiva o mašinama 2006/42/EC, Prilog II, deo A)</p> <ol style="list-style-type: none"> <li>1. Preduzeće</li> <li>2. Daje izjavu pod vlastitom odgovornošću da je mašina: Lančana motorna testera za šumarstvo</li> <li>Obaranje i seča drveća/rezanje grana</li> <li>a) Tip / Osnovni model</li> <li>b) Mesec /Godina proizvodnje</li> <li>c) Serijski broj</li> <li>d) Motor: motor s unutrašnjim sagorevanjem</li> <li>3. u skladu s osnovnim zahtjevima direktiva:       <ol style="list-style-type: none"> <li>e) Sertifikaciono telo</li> <li>f) EC ispitivanje tipa:           <ol style="list-style-type: none"> <li>4. Pozivanje na usklađene norme</li> <li>g) Izmereni nivo zvučne snage</li> <li>h) Garantovani nivo zvučne snage</li> <li>i) Širina košenja.....</li> <li>j) Neto instalirana snaga</li> <li>n) Osoba ovlašćena za sastavljanje tehničke brošure</li> <li>o) Mesto i datum</li> </ol> </li> </ol> </li> </ol> | <p>BG (Превод на оригиналните инструкции)</p> <p>EO декларация за съответствие (Директива Машина 2006/42/EO, Приложение II, част A)</p> <ol style="list-style-type: none"> <li>1. Дружеството</li> <li>2. На собствена отговорност декларира, че машината: Моторен верижен трион за горки работи, Сеч/нарязване на трупи/окастряне клоните на дървета</li> <li>a) Вид / Базисен модел</li> <li>b) Месец / година на производство</li> <li>c) Сериен номер</li> <li>г) Мотор: мотор с вътрешно горене</li> <li>3. Е в съответствие със спецификата на директивите:       <ol style="list-style-type: none"> <li>d) Сертифициращ орган</li> <li>e) EO изследване на вида</li> <li>4. Базирано на хармонизираните норми</li> <li>ж) Ниво на измерена акустична мощност</li> <li>и) Гарантирано ниво на акустична мощност</li> <li>к) Нетна инсталирана мощност</li> <li>р) Лице, упълномощено да състави Техническата Документация:           <ol style="list-style-type: none"> <li>o) Място и дата</li> </ol> </li> </ol> </li> </ol> | <p>ET (Algupärase kasutusjuhendi tõlge)</p> <p>EÜ vastavusdeklaratsioon (Masinadirektiiv 2006/42/EÜ, Lisa II, osa A)</p> <ol style="list-style-type: none"> <li>1. Firma</li> <li>2. Kinnitab omal vastutusel, et masin: Kettisaag metsatöödeks</li> <li>Puude langemine/järkamine/laasimine</li> <li>a) Tüüp / Põhimudel</li> <li>b) Kuu aega / Tootmisaasta</li> <li>c) Matrikel</li> <li>d) Mootor: Sise põlemismootor</li> <li>3. Vastab direktiivide nõuetele:       <ol style="list-style-type: none"> <li>e) Kinnitav asutus</li> <li>f) EÜ tüübihindamine</li> <li>4. Viide ühtlustatud standarditele</li> <li>g) Mõõdetud helivõimsuse tase</li> <li>h) Garanteeritud helivõimsuse tase</li> <li>j) Installeeritud netovõimsus</li> <li>n) Tehnilise Lehe autoriseeritud koostaja:           <ol style="list-style-type: none"> <li>o) Koht ja Kuupäev</li> </ol> </li> </ol> </li> </ol>  |



**IT** • Il contenuto e le immagini del presente manuale d'uso sono stati realizzati per conto di ST. S.p.A. e sono tutelati da diritto d'autore – È vietata ogni riproduzione o alterazione anche parziale non autorizzata del documento.

**BG** • Съдържанието и изображенията в настоящото ръководство са извършени за ST. S.p.A. и са защитени с авторски права – Забранява се всяко неоторизирано възпроизвеждане или промяна, дори и отчасти на документа.

**BS** • Sadržaj i slike iz ovog korisničkog priručnika napravljeni su isključivo za ST. S.p.A. i zaštićeni su autorskim pravima – zabranjena je svaka neovlaštena reprodukcija ili izmjena dokumenta, djelomično ili u potpunosti.

**CS** • Obsah a obrázky v tomto návodu k použití byly zpracovány jménem společnosti ST. S.p.A. a jsou chráněny autorským právem – Reprodukce či nepovolené pozměňování tohoto dokumentu, a to i částečné, je zakázáno.

**DA** • Indhold og illustrationer i denne vejledning er blevet skabt på vegne af ST. S.p.A. og er beskyttet af ophavsret – Enhver gengivelse eller ændring, også delvis, af dokumentet uden autorisation hertil er forbudt.

**DE** • Inhalt und Bilder dieser Bedienungsanleitung wurden im Namen von ST. S.p.A. erstellt und sind urheberrechtlich geschützt – Jede nicht genehmigte Vervielfältigung oder Veränderung, auch auszugsweise, dieses Dokuments ist verboten.

**EL** • Το περιεχόμενο και οι εικόνες στο παρόν εγχειρίδιο χρήσης δημιουργήθηκαν για λογαριασμό της εταιρείας ST. S.p.A. και προστατεύονται από πνευματικά δικαιώματα – Απαγορεύεται οποιαδήποτε αναπαραγωγή ή τροποποίηση, έστω και μερική, του εγχειρίδιου χωρίς έγκριση.

**EN** • The content and images in this User Manual were produced expressly for ST. S.p.A. and are protected by copyright – any unauthorised reproduction or modification to the document, either partially or in full, is prohibited.

**ES** • El contenido y las imágenes del presente manual de uso han sido creados por ST. S.p.A. y están protegidos por los derechos de autor – Se prohíbe toda reproducción o modificación, incluso parcial, no autorizada del documento.

**ET** • Käesoleva kasutusjuhendi sisu ja kujutised on toodetud konkreetselt ettevõttele ST. S.p.A. ja neile rakendub autoriõigusseseadus – dokumendi igasugune osaline või täielik ilma loata reprodutseerimine või muutmine on keelatud.

**FI** • Tämän käyttöoppaan sisältö ja kuvat on valmistettu ST. S.p.A. -yhtiön toimesta ja niitä suojaa tekijänoikeuslaki. – Asiakirjan kaikenlainen kopioiminen tai muuttaminen, osittainkin, on kielletty ilman erityistä lupaa.

**FR** • Le contenu et les images du présent manuel d'utilisation ont été réalisés pour le compte de ST. S.p.A. et sont protégés par un droit d'auteur – Toute reproduction ou modification non autorisée, même partielle, du document, est interdite.

**HR** • Sadržaj i slike u ovom priručniku za uporabu izrađeni su za tvrtku ST. S.p.A. te su obuhvaćeni autorskim pravima – Zabranjuje se neovlašteno umnožavanje ili prilagodba, djelomična ili u cijelosti, ovog dokumenta.

**HU** • Ennek a használati útmutatónak a tartalma és a benne szereplő képek kizárólag a ST. S.p.A. számára készültek és szerzői joggal védettek – tilos a dokumentum bármely részének vagy egészének engedély nélküli sokszorosítása és módosítása.

**LT** • Šio naudotojų vadovo turinys ir paveikslėliai skirti tik „ST. S.p.A.“ ir yra saugomi autorių teisėmis – dokumentą atgaminti ar modifikuoti, visiškai arba iš dalies, yra draudžiami.

**LV** • Šis lietotāja rokasgrāmatas saturs un attēli ir veidoti tikai ST. S.p.A. un ir aizsargāti ar autortiesībām. Jebkāda dokumenta vai tā daļas prettiesiska kopēšana vai pārveide ir stingri aizliegta.

**MK** • Содржината и сликите во Упатството за корисникот се подготвени исклучиво за ST. S.p.A. и се заштитени со авторски права – забрането е секое делумно или целосно неовластено репродуцирање или измена на документот.

**NL** • De inhoud en de afbeeldingen van deze gebruikshandleiding werden gerealiseerd voor rekening van ST. S.p.A. en zijn beschermd door het auteursrecht – Elke niet-geautoriseerde reproductie of wijziging, ook gedeeltelijke, van het document is verboden.

**NO** • Innholdet og bildene i denne brukerveiledningen er utført på oppdrag fra ST. S.p.A. og er beskyttet ved opphavsrett – Enhver gjengivelse eller endring, selv kun delvis, er forbudt.

**PL** • Treść oraz ilustracje zawarte w niniejszej instrukcji obsługi powstały na zlecenie spółki ST. S.p.A. i są chronione prawami autorskimi – Zabrania się wszelkiego kopiowania bądź modyfikowania, także częściowego, niniejszego dokumentu bez uzyskania stosownej zgody.

**PT** • As imagens e os conteúdos contidos no presente Manual do Utilizador foram expressamente criados para uso exclusivo da ST. S.p.A., encontrando-se protegidos por direitos de autor. Qualquer tipo de reprodução ou alteração, parcial ou integral, não autorizadas deste Manual estão expressamente proibidas.

**RO** • Conținutul și imaginile din manualul de utilizare de față au fost realizate în numele ST. S.p.A. și sunt protejate de drepturi de autor – Este interzisă orice reproducere sau modificare chiar și parțială neautorizată a documentului.

**RU** • Тесты и изображения, содержащиеся в настоящем руководстве, были созданы в интересах ST. S.p.A. и защищены авторскими правами – Любое несанкционированное воспроизведение или изменение документа запрещено.

**SK** • Obsah a obrázky v tomto návode na používanie boli spracované menom spoločnosti ST. S.p.A. a sú chránené autorským právom – Reprodukcie či nepovolené pozměňovanie tohto dokumentu, a to aj čiastočné, je zakázané.

**SL** • Vsebine in slike v tem uporabniškem priručniku so izdelane za podjetje ST. S.p.A. in so zaščitene z avtorskimi pravicami – vsakršno nepooblaščenno razmnoževanje ali spreminjanje dokumenta, v celoti ali delno, je prepovedano.

**SR** • Sadržaj i slike ovog priručnika za upotrebu su napravljeni u ime ST. S.p.A. i zaštićeni su autorskim pravima – Zabranjena je svaka potpuna ili delimična reprodukcija ili izmena dokumenta bez odobrenja.

**SV** • Innehållet och bilderna i denna användarhandbok har framställts för ST. S.p.A. och skyddas av upphovsrätt – all form av reproduktion eller ändring, även partiell, som inte auktoriserats är förbjuden.

**TR** • Bu Kullanıcı Kilavuzundaki içerik ve resimler açığa ST. S.p.A. için üretilmiştir ve telif hakkı ile korunmaktadır – dokümanın izinsiz olarak tamamen ya da kısmen herhangi bir şekilde çoğaltılması ya da dağıtılması yasaktır.



|                                 |   |
|---------------------------------|---|
|                                 |  <b>LWA</b><br><br><b>dB</b> |
| Type: .....                     |   |
| Art.N .....<br>..... -s/n ..... |   |



**FR**

Cet appareil,  
ses accessoires,  
piles et cordons  
se recyclent

À DÉPOSER  
EN MAGASIN  
OU  
À DÉPOSER  
EN DÉCHÈTERIE

Points de collecte sur [www.quefairedemesdechets.fr](http://www.quefairedemesdechets.fr)  
Privilégiez la réparation ou le don de votre appareil !



**FR**

**ST. S.p.A.**  
Via del Lavoro, 6  
31033 Castelfranco Veneto (TV) ITALY

**STIGA LTD (UK Importer)**  
Unit 8, Bluewater Estate Plympton,  
Devon, PL7 4JH, England