

HERO 11
BLACK
MINI

Join the GoPro Movement



@GoPro



@GoPro



@GoPro



facebook.com/GoPro



@GoPro



pinterest.com/GoPro

Contents

Meet HERO11 Black Mini	6
Setting Up Your Camera	8
Connecting to the GoPro Quik App	12
Updating Your Camera's Software	15
Button Basics	17
Turning Your Camera Off	18
The Capture Screen + Default Settings	19
Recording with QuikCapture	20
Using Easy Controls	21
Switching Between Easy + Pro Controls	23
Pro Control Capture Modes	24
Pro Control Settings	27
Live Streaming	31
HiLight Tags	32
Controlling Your GoPro With Your Voice	33
Playing Back + Transferring Your Media	35
Creating Video Stories	39
Capturing Photos from Your Videos	40
Setting Preferences With the Quik App	41

Contents

Important Messages	44
Resetting Your Camera	47
Mounting Your GoPro	48
Removing the Door	54
Maintenance	56
Battery Information	57
Troubleshooting	60
Navigating with the Camera Buttons	61
Tech Specs	67
Protune	85
Customer Support	93
Trademarks	93
Regulatory Information	93

Meet HERO11 Black Mini

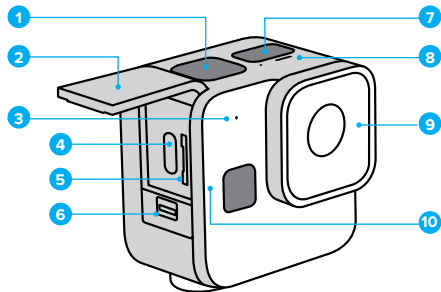

- 1. Shutter Button 
- 2. Door
- 3. Microphone
- 4. USB-C Port
- 5. microSD™ Card Slot

- 6. Door Latch
- 7. Status Screen
- 8. Status Light
- 9. Removable Lens Cover
- 10. Status/Pair Button 

Meet HERO11 Black Mini

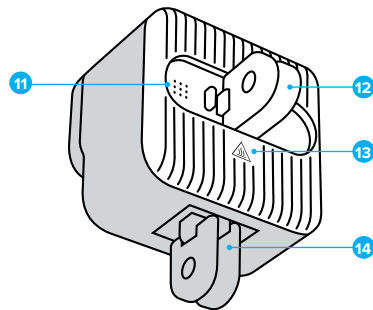

- 11. Speaker
- 12. Rear Folding Fingers
- 13. Heat Sink

(WARNING: To help prevent overheating, the back of your camera may get hot when camera is in use.)

- 14. Bottom Folding Fingers

Learn how to use the accessories that came with your GoPro. See [Mounting Your GoPro](#) (page 48).

Setting Up Your Camera

SD CARDS

You'll need a microSD card (sold separately) to save your videos.

Use a brand-name card that fits these requirements:

- microSD, microSDHC™, or microSDXC™
- Rated Class V30, UHS-3, or higher
- Capacity up to 512GB

For a list of recommended microSD cards, visit [GoPro.com/microsdcards](https://www.gopro.com/microsdcards).







Be sure your hands are clean and dry before handling your SD card. Check the manufacturer's guidelines to see your card's acceptable temperature range and other important information.

Heads Up: SD cards can degrade over time and affect your camera's ability to save your media. Try swapping out an older card for a new one if you're having any problems.

Setting Up Your Camera

REFORMATTING YOUR SD CARD

Keep your SD card in good condition by reformatting it regularly. This will erase all of your media, so be sure to save it first.

1. Press the Status/Pair button  to turn on your camera.
2. Press the Status/Pair button again to go to your camera's Preferences (press twice if you're using Pro Controls).
3. Press the Shutter button  repeatedly until you get to Format SD.
4. Press the Status/Pair button to select Format SD.
5. Press the Status/Pair button to cycle from the  to the 
(or press the Shutter button with the  highlighted to go back).
6. Press Shutter button (with  highlighted) to confirm that you want to format your SD card.

For more, see [Using Buttons to Adjust Camera Preferences](#) (page 65).

Setting Up Your Camera

SD CARD + BATTERY SETUP

1. Unlock the door latch and flip the door open.

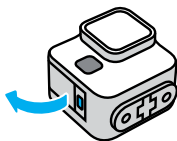

With your camera off, insert the SD card into the card slot with the label facing the back of the camera.

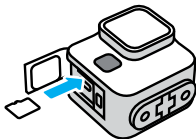

You can eject the card by pressing it into the slot with your fingernail.

NOTE: Only eject the SD card when your camera is off. Removing the SD card while your camera is on could permanently damage your camera.

Setting Up Your Camera

2. Connect your camera to a USB charger or computer using the included USB-C cable. It takes about 2 hours for the battery to fully charge. The camera status light will turn off when it's done.

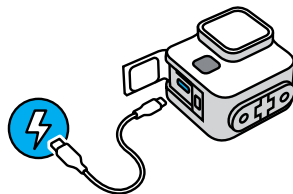

To learn more, see [Battery Information](#) (page 57).

Heads Up: The battery cannot be removed from the camera.

3. Unplug the cable and shut the door when charging is complete. Be sure the door latch is closed and locked before using your camera.

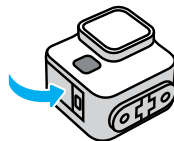

NOTE: Your camera's door is removable. Be sure that the door is securely locked and sealed after closing.

Connecting to the GoPro Quik App

The GoPro Quik app is the easiest way to adjust your camera's modes, settings, and preferences. The app also lets you preview your shot, frame it perfectly, and see all of the footage stored on your camera's SD card, and can automatically transform your footage into awesome video stories synced with effects and music.

FIRST-TIME APP PAIRING + CAMERA SETUP

1. Download the GoPro Quik app from the Apple® App Store® or Google Play™.
2. Press the Status/Pair button  on your camera to turn it on. After the HERO11 Black Mini screen, you'll choose your language.





3. Press the Status/Pair button repeatedly until you find your preferred language.





4. Press the Shutter button  to select your language.



5. Press the Shutter button (with  highlighted) to confirm. Press the Status/Pair button to cycle to the  and press the Shutter button to go back.



Connecting to the GoPro Quik App

6. Press the Shutter button (with  highlighted) to accept the terms of use. Press the Status/Pair button to cycle to the  and press the Shutter button to go back.



7. Start the GoPro Quik app on your phone and follow the Quik app's on-screen instructions to connect your camera and complete your setup.





Heads Up for iOS®: When prompted, be sure to allow notifications from the GoPro Quik app so you know when your video is ready. To learn more, see [Creating Video Stories](#) (page 39).

Connecting to the GoPro Quik App

AFTER FIRST-TIME PAIRING + PAIRING OTHER DEVICES

Your camera should automatically connect to the GoPro Quik app after the first-time pairing. Here's how you can re-pair the app if needed or pair other devices:

1. Press the Status/Pair button  to turn on your camera.
2. Press the Status/Pair button again to go to your camera's preferences (press twice if you're using Pro Controls).
3. Press the Shutter button  repeatedly until you get to Pairing.
4. Press the Status/Pair button to start pairing.

Heads Up: Pressing any button after pairing has started will cancel pairing.

For more, see [Using Buttons to Adjust Camera Preferences](#) (page 65).

Updating Your Camera's Software

To get the latest features and best performance from your GoPro, make sure it's using the most current software.

UPDATING WITH THE GOPRO QUIK APP

The app will check for new camera software each time it connects to your camera. If new camera software is available, the app will tell you how to install it.

UPDATING MANUALLY



1. Visit [GoPro.com/update](https://gopro.com/update).
2. Choose *HERO11 Black Mini* from the list of cameras.
3. Select *Update your camera manually* and follow the instructions.

Updating Your Camera's Software



YOUR CAMERA'S SOFTWARE VERSION

Want to know what software version you're using? Here's where you can find out.

Using the GoPro Quik App

1. After connecting to the GoPro Quik app, tap / on the app screen.
2. Scroll down to Camera Info.

Using your camera's buttons



1. Press the Status/Pair button  to turn on your camera.
2. Press the Status/Pair button again to go to your camera's preferences (press twice if you're using Pro Controls).
3. Press the Shutter button  repeatedly until you to About.
4. Press the Status/Pair button to see your camera's software version.
Heads Up: Your camera's serial number will scroll three times before showing you the software version.
5. Press the Shutter button to exit to the capture screen.

For more, see [Using Buttons to Adjust Camera Preferences](#) (page 65).

Button Basics



Your camera's buttons perform different functions depending on whether your camera is on or off.

When Your Camera is Off

- Press the Status/Pair button  to turn on your camera.
- Press the Shutter button  to power up your camera and start recording immediately. Press again to stop recording and power off your camera.

To learn more, see [Recording with QuikCapture \(page 20\)](#).

When Your Camera is On

- Press the Status/Pair button  to access and cycle through Preferences, Videos Modes, and Video Settings.
- Press the Shutter button  to start and stop recording, and confirm Preferences, Video Modes, and Video Settings.
- Press and hold the Status/Pair button  for 3 seconds to turn your camera off.

Turning Your Camera Off

TURNING OFF YOUR CAMERA MANUALLY

Press and hold the Status/Pair button  for 3 seconds to turn your camera off at any time.

Heads Up: Your camera will save your footage before shutting down if you turn it off while recording.

AUTO OFF

HERO11 Black Mini will automatically turn itself off after a period of inactivity to help maximize battery life. The length of the inactive period will vary based on what you are doing with your camera at the time of shutdown.

8-Second Auto Off

If your camera is on and ready to record, it will turn itself off after 8 seconds of inactivity.

15-Second Auto Off

If you are in the middle of changing modes, settings, or preferences, your camera will turn itself off after 15 seconds of inactivity.

The Capture Screen + Default Settings

THE CAPTURE SCREEN

This is the screen you'll see when your camera is ready to record. Simply press the Shutter button  to start recording.



1. Remaining Recording Time
2. Battery Status
3. Capture Settings

The screen also shows the recording time when you are actively capturing footage and important messages about your camera's status.

To learn more, see [Important Messages](#) (page 44).

DEFAULT SETTINGS

HERO11 Black Mini is set up to record in Video mode using Pro Controls out of the box. This will give you widescreen 4K video at 60 frames per second using the Wide digital lens. These ultra versatile settings are great for capturing most shots.

Recording with QuikCapture

HERO11 Black Mini's 1-touch recording feature, QuikCapture, is the fastest and easiest way to power on your GoPro and start recording. It also maximizes battery life because it only turns the camera on when you're recording and turns it off when you're done.

USING QUIKCATURE

1. With your camera off, press the Shutter button . It will start recording with the video mode that you used last.

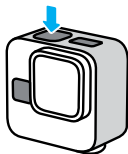

2. Press the Shutter button again to stop recording and automatically turn off your camera.

Heads Up: You can also record by first turning your camera on by pressing the Status/Pair button , followed by the Shutter button to start recording.



WARNING: Use caution when using your GoPro and its mounts and accessories. Always be aware of your surroundings to avoid injuring yourself and others.

Be sure to follow all local laws including all privacy laws, which may restrict recording in certain areas.

Using Easy Controls

HERO11 Black Mini makes it easier than ever capture incredible video of your adventures. Easy Controls are preloaded with ultra versatile capture settings that are great for most shots. Just point and shoot.

VIDEO MODES

Easy Controls feature three video mode options designed to give you great footage simply by pressing the Shutter button .

Extended Battery (Default)

Captures mid-range 4K video to help you capture stunning footage while extending battery life. It uses the SuperView digital lens, which serves up your footage as an immersive 16:9 aspect ratio shot for full-screen playback on your TV. Records at 60 frames per second, which lets you play back your video in 2x slow motion (half speed).

Longest Battery

Records 1080p footage for the best possible battery life and maximum compatibility when playing back your video on older devices. Uses the SuperView digital lens to capture immersive 16:9 aspect ratio footage for full-screen playback on your TV. Records at 60 frames per second, which lets you play back your video in 2x slow motion (half speed).

Highest Quality

This setting records your adventures in stunning 5.3K video—our highest resolution for the best possible footage. It uses the SuperView digital lens to capture immersive footage in the 16:9 aspect ratio for full-screen playback on your TV at 60 frames per second, which lets you play back your video in 2x slow motion (half speed).

To learn more, see

- [Aspect Ratio \(Video\)](#) (page 71)
- [Video Resolution \(RES\)](#) (page 67)
- [Frames Per Second \(FPS\)](#) (page 69)

Using Easy Controls

Heads Up: Easy Control video modes are optimized for easy point-and-shoot capture. They cannot be adjusted.



CHANGING VIDEO MODES

You can use the GoPro Quik app or your camera's buttons to switch video modes.

Using the GoPro Quik app

1. After connecting to the GoPro Quik app, tap  on the app screen.
2. Choose the mode you want.

Using your camera's buttons

1. Press the Status/Pair button  to turn on your camera.
2. Press the Status/Pair button again to go to your camera's preferences.
3. Press the Shutter button  once to access Video Modes.
4. Press Status/Pair repeatedly to cycle through Video modes.
5. Press the Shutter button to lock in the mode of your choice.
6. Press the Shutter button to pass through the remaining options and exit to the capture screen.

For more, see [Using Button to Switch Video Modes \(Easy Controls\)](#) (page 61).

Switching Between Easy + Pro Controls

With Easy Controls, all you have to do is press the Shutter button to start recording with one of HERO11 Black Mini's ultra versatile video modes. Pro Controls to unlock additional capture modes, plus the ability to adjust all of your camera's modes, settings, and features.

SWITCHING CONTROLS



You can use the GoPro Quik app or your camera's buttons to switch between Easy and Pro Controls.

Using the GoPro Quik app

1. After connecting to the GoPro Quik app, tap  on the app screen.
2. Find the Controls setting and tap to switch between Easy and Pro Controls.

PRO TIP: You can also tap the  on app's home screen to quickly toggle between Easy and Pro Controls.

Using your camera's buttons

1. Press the Status/Pair button  to turn on your camera.
2. Press the Status/Pair button again to go to your camera's preferences (press twice if you're using Pro Controls).
3. Press the Shutter button  repeatedly until you get to Controls.
4. Press the Status/Pair button to toggle between Easy and Pro Controls.
5. Press the Shutter button to lock in your choice.

For more, see [Using Buttons to Adjust Camera Preferences](#) (page 65).

Pro Control Capture Modes

Pro Control comes loaded with seven video capture modes. Each has its own specialty. Once you've locked a mode into your camera, simply press the Shutter button  to start recording.

Heads Up: These modes are only available when using the Pro Controls.

PRO TIP: Each video mode is completely customizable. You can adjust the resolution, frame rate, digital lens, and more.

To learn more, see [Pro Control Settings](#) (page 27).

VIDEO (DEFAULT)

Video mode is set up to capture traditional footage using 4K video at 60 frames per second with the Wide digital lens in the 16:9 aspect ratio.

TIMEWARP

TimeWarp lets you speed up time by recording frames of video at set intervals. The result is a fast-motion effect when you play back your video. TimeWarp automatically stabilizes your video—making it ideal for capturing ultra smooth time lapse video of your activities and any time you're on the move.

STAR TRAILS

Mount your camera to a stationary object or tripod, point it toward the night sky, and let physics take over. Star Trails uses the Earth's rotation and the stars to create beautiful trails of light across the sky. Use the trail length effect to choose maximum, long, or short trail lengths.

Pro Control Capture Modes

LIGHT PAINTING

Light Painting uses a long exposure to let you create brilliant brush stroke effects with moving light. Mount your camera to a stationary object or tripod, grab a flashlight, glow stick, or other light source, and get creative.

VEHICLE LIGHT TRAILS

Mount your camera to a stationary object or tripod and point your camera at moving vehicles to create stunning light trail footage. Be sure to use the trail length effect to choose maximum, long, or short trail lengths.

TIME LAPSE

Time Lapse turns long events into short, shareable videos by taking a frame of video at set intervals. Use it to capture time lapse video when your camera is mounted and still. It's great for sunsets, street scenes, art projects, and other shots that unfold over a long period of time.

NIGHT LAPSE

Night Lapse was made to capture time lapse video in dark and low-light environments. It automatically adjusts the shutter speed to let in more light and picks the interval that will give you the best results. Night Lapse isn't recommended for handheld or mounted shots when the camera is moving.

Pro Control Capture Modes



CHANGING CAPTURE MODES

You can use the GoPro Quik app or your camera's buttons to switch between capture settings when using Pro Controls.

Using the GoPro Quik app

1. After connecting to the GoPro Quik app, tap  on the app screen.
2. Choose the mode you want.

Using your camera's buttons

1. Press the Status/Pair button  to turn on your camera.
2. Press the Status/Pair button again to go to your camera's Video Settings.
3. Press the Shutter button  access Modes.
4. Press the Status/Pair button repeatedly to cycle through Modes.
5. Press the Shutter button to lock in the mode of your choice.
6. Press the Shutter button to pass through the remaining options and exit to the capture screen.

For more, see [Using Buttons Switch Video Modes \(Pro Controls\)](#) (page 62).

Pro Control Settings

You can adjust each mode's capture settings when using your camera's Pro Controls. Aspect ratio, lens, frame rate, and other primary settings can be changed using either your camera's buttons or the GoPro Quik app. All other settings can only be adjusted using the Quik app.

PRO TIP: The GoPro Quik app is the quickest and easiest way to adjust your camera's settings.

ASPECT RATIO

Aspect ratio refers to the width and height of an image. Your camera captures footage in the 16:9 widescreen format, tall 4:3 format, and ultra immersive 8:7 aspect ratios.

To learn more, see [Aspect Ratio \(Video\)](#) (page 71).

RESOLUTION

Resolution refers to the number of horizontal lines used in a frame of video. The more lines, the more detail there is in the shot. Your camera can capture 5.3K, 4K, 2.7K, and 1080p footage.

To learn more, see [Video Resolution \(RES\)](#) (page 67).

LENS

Choose the best digital lens for your shot—SuperView, HyperView, Linear, Linear + Horizon Lock/Leveling, or Wide. Available lenses will vary based on the resolution and frame rate you select.

To learn more, see [Digital Lenses \(Video\)](#) (page 72).

Pro Control Settings

FRAMES PER SECOND

Frames per second (fps) refers to the number of frames captured in each second of video. Use higher frame rates to capture fast action or slo-mo shots. Available frame rates vary based on resolution.

To learn more, see [Frames Per Second \(FPS\)](#) (page 69).

SPEED (TIMEWARP)

Set your video speed. Choose a lower speed (2x or 5x) for short activities or higher speeds (10x, 15x, or 30x) for longer activities. Leave speed on Auto (default) to let your GoPro automatically adjust the speed based on motion, scene detection, and lighting.

To learn more, see [TimeWarp Video Speed](#) (page 79).

TRAIL LENGTH EFFECT (STAR TRAILS, LIGHT PAINTING, VEHICLE LIGHT TRAILS)

Set the length of light trails when capturing Star Trails footage. Choose Max for continuous trails with no breaks, long trails, or short trails.

SHUTTER (STAR TRAILS, LIGHT PAINTING, VEHICLE LIGHT TRAILS, NIGHT LAPSE)

Set how long your camera's shutter stays open for night shots. Choose longer exposures for darker shots.

To learn more, see [Shutter \(Star Trails, Light Painting, Vehicle Light Trails, Night Lapse\)](#) (page 83).

Pro Control Settings

INTERVAL (TIME LAPSE)

Choose how often your camera captures a frame of video. Use shorter intervals for quick activities and longer intervals for extended activities.

To learn more, see [Interval \(Time Lapse\)](#) (page 81).

INTERVAL (NIGHT LAPSE)

Set how often your camera takes a shot in low and ultra low-light scenes. Leave Interval on Auto (default) to let your GoPro automatically set the interval. Choose short intervals for scenes with a lot of movement and more light. Use longer intervals in scenes with little or no movement or light.

To learn more, see [Interval \(Night Lapse\)](#) (page 84).

HYPERSMOOTH (VIDEO)

Perfect for biking, skiing, handheld shots, and more, HyperSmooth video stabilization delivers insanely smooth, gimbal-like footage without the gimbal. The available settings are Off, On (default), Boost, and AutoBoost.

Heads Up: HyperSmooth can only be adjusted using the GoPro Quik app.



To learn more, see [HyperSmooth Video Stabilization](#) (page 78).

Pro Control Settings



ADJUSTING SETTINGS

You can use the GoPro Quik app or your camera's buttons to adjust capture settings.

Using the GoPro Quik app

1. After connecting to the GoPro Quik app, tap  on the app screen.
2. Tap  next to the mode that you want to adjust.
3. Tap the setting to make adjustments.

Using your camera's buttons



1. Press the Status/Pair button  to turn on your camera.
2. Press the Status/Pair button again to go to your camera's Video Settings.
3. Press the Shutter button  to access Modes.
4. Use the Status/Pair button to cycle through your options. Stop on the mode that you want to adjust and press the Shutter button to lock it in.
5. Press the Shutter button repeatedly to cycle through the settings for that mode. Stop on the setting you want to adjust. Settings vary by model.
6. Press the Status/Pair button to cycle through the options for that setting.
7. Press the Shutter button to lock in the setting that you want.
8. Press the Shutter button to pass through the remaining options and exit to the capture screen.

Heads Up: You can restore your camera's default settings by restoring the factory settings.

For more, see [Restoring Factory Settings](#) (page 47).

Live Streaming



SETTING UP A LIVE STREAM

1. Connect to the GoPro Quik app. For details, see [Connecting to the GoPro Quik App](#) (page 12).
2. In the app, tap  to control your camera.
3. Tap  and follow the instructions to set up your stream.

For complete step-by-step instructions, visit [GoPro.com/live-stream-setup](https://gopro.com/live-stream-setup).

HiLight Tags

ADDING HIGHLIGHT TAGS

Mark favorite moments by pressing the Status/Pair button  during recording. This adds a HiLight Tag  that makes those moments easier to find when you're watching your footage, creating a video, or looking for a certain shot. The GoPro Quik app also uses HiLight Tags to find the best footage when creating highlight videos.

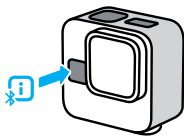

You can also add HiLight Tags by saying, "GoPro, HiLight" when Voice Control is on and by tapping  when watching your footage with the GoPro Quik app.



Heads Up: Once added, HiLight Tags cannot be removed.

PRO TIP: The Quik app looks for HiLight Tags when it creates videos. This helps to ensure that favorite moments are included in your stories.

Controlling Your GoPro With Your Voice

Voice Control gives you easy, hands-free control of your GoPro. It's great when you're busy with handlebars, ski poles, and more. Just tell your GoPro what you want it to do.

TURNING VOICE CONTROL ON + OFF

1. After connecting to the GoPro Quik app, tap   on the app screen.
2. Tap Voice Control to toggle on and off.

VOICE COMMANDS



Here are all of the things that can be done with voice commands.

Command	Description
GoPro, capture	Starts capturing with the mode your camera is set to.
GoPro, stop capture	Stops capture in the mode your camera is set to.
GoPro, start recording	An alternative to "GoPro, capture"
GoPro, stop recording	An alternative to "GoPro, stop capture"
GoPro, HiLight	Adds a HiLight Tag to your video during recording.
GoPro, turn off	Turns your camera off.

PRO TIP: Voice commands will start capture using the mode and settings you currently have on your camera. Make sure you have the mode and settings you want dialed in before you start recording.

Controlling Your GoPro With Your Voice

CHANGING YOUR VOICE CONTROL LANGUAGE

1. After connecting to the GoPro Quik app, tap   on the app screen.
2. Tap Voice Control Language.

Heads Up: Voice Control may be affected by wind, noise, and your distance from the camera. Keep your camera clean and wipe away any debris for the best performance.

Playing Back + Transferring Your Media

PLAYING BACK ON YOUR PHONE

1. Connect to the GoPro Quik app and tap View Media  to see your media on your phone.
For details, see [Connecting to the GoPro Quik App](#) (page 12).
2. Use the controls on the app to play back, edit, and share your videos.

PRO TIP: Use the GoPro Quik app to grab still photos from videos, create short shareable videos from full-length footage, save media to your phone, and more.

PLAYING BACK ON A COMPUTER

For desktop editing and viewing your media on a computer, you must first save the files to the computer.

1. Remove the SD card from your camera.
2. Insert the card into an SD card reader or adapter.
3. Plug the card reader into your computer's USB port, or insert the adapter into the SD card slot.
4. Copy the files to your computer.

Playing Back + Transferring Your Media

TRANSFERRING TO YOUR PHONE WITH A WIRED CONNECTION

Use a wired connection to transfer videos from your GoPro to your phone faster and more reliably.

1. Use the appropriate cable/adaptor (not included) to connect your GoPro to your phone.
2. Start the GoPro Quik app on your phone and follow the on-screen instructions.

Phone	Require Cable or Adapter
Android	Standard USB-C to USB-C
iOS® device with USB-C port	Standard USB-C to USB-C
iOS® device with Lightning port	Standard USB-A to USB-C and Apple® Lightning to USB Camera Adapter

Playing Back + Transferring Your Media

AUTO UPLOADING TO THE CLOUD

With a GoPro subscription, you can automatically upload your media to the cloud where you can view, edit, and share it from any device. Your uploaded footage will also be used to create shareable highlight videos that will be sent straight to your phone.

1. Subscribe to GoPro at GoPro.com/subscribe or through the GoPro Quik app.
2. Connect your camera to the GoPro Quik app. For details, see [Connecting to the GoPro Quik App](#) (page 12).
3. Tap Auto Upload when prompted or tap  on the app screen.
4. Follow the app's onscreen instructions.
5. Connect your camera to a power outlet. The upload will start automatically.

After first-time setup, your camera won't need to connect to the app to start Auto Upload.

Heads Up: Your original files remain on your camera even after they've been backed up to the cloud.

ACCESSING YOUR CLOUD MEDIA

1. Open the GoPro Quik app on your device.
2. Tap  and select Cloud to view, edit, and share your content.

PRO TIP: Use your cloud media to create video stories with the GoPro Quik app. Simply choose Cloud Media when you start a new story.

Playing Back + Transferring Your Media

TURNING OFF AUTO UPLOAD

You can keep your camera from trying to upload every time it's connected to a power outlet and fully charged.

1. Connect your camera to the GoPro Quik app.
2. Tap  on the camera chooser screen.
3. Tap Auto Upload off.

CONNECTING TO A DIFFERENT WIRELESS NETWORK

1. Connect your camera to the GoPro Quik app. For details, see [Connecting to the GoPro Quik App](#) (page 12).
2. After connecting, tap Manage Auto Upload on the app.
3. Tap Wi-Fi Networks on the app.
4. Choose a Wi-Fi network.
5. Enter the Wi-Fi password.
6. Tap Connect.

Creating Video Stories

You can set up your GoPro to automatically send your shots to your phone. The GoPro Quik app will use them to create a fully edited video story complete with music and effects.

1. Connect your camera to the GoPro Quik app. For details, see [Connecting to the GoPro Quik App](#) (page 12).
2. Swipe down on the app's home screen. Shots from your most recent session will be copied to your phone and transformed into a fully edited video.
3. Tap your video to view it.
4. Make any edits you'd like.
5. Save the story or share it with your friends, family, and followers.

FINDING THE BEST SHOTS

Be sure to mark your best shots with HiLight Tags. The GoPro Quik app looks for tags when it creates videos. This helps ensure that favorite moments are included in your stories.



Your GoPro also knows when you face the camera, smile, and more. It automatically tags these shots with data so the app can handpick them for your videos.

To learn more, see [HiLight Tags](#) (page 32).

Capturing Photos from Your Videos

HERO11 Black Mini's 5.3K footage gives you more than great high-resolution videos. It also lets you capture high-quality photos up to 24.7MP from your videos using the GoPro Quik app.

FRAME GRAB WITH THE GOPRO QUIK APP

1. Connect your camera to the GoPro Quik app. For details, see [Connecting to the GoPro Quik App](#) (page 12).
2. Tap View Media  to see a video on your phone. You can choose any video stored in the app, in the cloud, or on your phone's camera roll.
3. Tap your video to view it.
4. Tap  when you see a great shot in your video to save the frame as a photo.
5. Choose whether to save the photo in the GoPro Quik app, save it in your phone's camera roll, or share it.

FRAME GRAB RESOLUTION

The resolution of your frame grab photos will vary based on settings used to capture your video. Here are some examples:

Photo Resolution	Video Settings
24.7MP	5.3K video, 8:7 aspect ratio (requires changing settings using Pro Controls)
21.16MP	5.3K video, 4:3 aspect ratio (requires changing settings using Pro Controls)
15.8MP	5.3K video, 16:9 aspect ratio (default Highest Quality video mode when using Easy Controls)

Setting Preferences With the Quik App

To adjust your camera's preferences, tap  after connecting to the GoPro Quik app.

SETUP

Set up your camera exactly the way you want it in just a few taps.

Controls

Switch between Easy and Pro Controls. You can also switch controls using your camera's buttons.

To learn more, see [Switching Between Easy + Pro Controls](#) (page 23).

Voice Control

Turn Voice Control on and off.

Voice Control Language

Choose your Voice Control language.

Wi-Fi Band

Choose 5GHz or 2.4GHz as your connection speed. Set 5GHz only if your phone and region support it.

Beeps

Set your camera's beep volume—High, Med (default), Low, or Mute.

LED

Turn the status light on (default) or off.

Setting Preferences With the Quik App

Orientation

Choose the orientation of your footage. All will lock in and record with the orientation that your camera was in when you started recording. Landscape will always record in landscape orientation regardless of your camera's orientation. Locked will use the orientation that your camera used last.

Language

Choose the language that appears on the camera.

Anti-Flicker

Choose the regional frame rate for recording and playback on a TV. Set 60Hz (NTSC) for North America. Try 50Hz (PAL) if you're outside of North America. The right format for your region will help prevent flicker on a TV/HDTV when you play back video that was recorded indoors.

Set Date and Time

Tap to automatically sync camera's date and time with the app.

DELETE

Manage the files on your SD card.

Delete Last File

Deletes the last video captured by your camera.

Delete All Files from SD Card

Removes all of the files from your SD card.

Setting Preferences With the Quik App

CAMERA INFO

See your camera's software version or find it if it's lost.

Version

See the software version your camera is currently using.

Locate Camera

Your camera will beep to let you know where it is.

CAMERA STATUS

Check out your camera's battery and SD card capacity.

Battery Level

See how much charge is left in your camera's battery.

SD Card Capacity

See how much space is left on your camera's SD card.

Important Messages

Problems are rare, but your GoPro will let you know if anything comes up. Here are some of the icons you might see on your camera's status screen and what they mean.



CAMERA IS TOO HOT

The Temperature icon appears on the status screen if your camera becomes too hot and needs to cool down. Your camera was designed to recognize when it's at risk of exceeding its thermal limits and will shut down when needed. Simply let it sit and cool before using it again.

Heads Up: The operating ambient temperature range of your HERO11 Black Mini is 14° F ~ 95° F (-10° C ~ 35° C). Its normal charging temperature range is 32° F ~ 95° F (0° C ~ 35° C). High temperatures will cause your camera to use more power and drain the battery faster.

PRO TIP: HERO11 Black Mini was made to capture action. The air that flows around the camera while recording action helps keep your camera cool. For the best performance and longest runtimes, make sure there is enough airflow around your camera when in use. You can also lower the resolution and frame rate to reduce the risk of your GoPro getting too hot. Shooting video at a high resolution and frame rate will cause your camera to heat up faster, especially in hot environments.

Important Messages



BATTERY IS TOO COLD

Your camera may not turn on or may not be able to record with high-performance settings if the battery is too cold (below 14° F, -10° C).

PRO TIP: For the best cold-weather performance, charge your camera to 100% before going out in the cold. Keep your camera in your pants, bib, or jacket pocket until you're ready to record.



SD CARD ERROR

Your GoPro can detect a variety of problems with your SD card. Problems can be due to, but not limited to, electrostatic discharge. Restart your camera if this occurs. It will automatically try to repair any damaged files and restore your camera back to full function.



REPAIRING YOUR FILE

Your GoPro will automatically try to fix damaged files. Files can be damaged if your camera loses power while recording or if there's a problem saving the file. The File Repair icon will appear on the touch screen when a repair is in progress. Your camera will let you know when it's finished and if the file was fixed.



MEMORY CARD FULL

Your camera will let you know when your SD card is full. You'll need to move or delete some files if you want to keep recording.

Important Messages



BATTERY LOW, POWERING OFF

A low-battery message will appear on the screen when the battery charge drops below 10%. If the charge runs out while recording video, your camera will stop recording, save the video, and turn itself off.



SD CARD RATING

Your camera needs an SD card rated V30, UHS-3, or higher to operate at its best. It will let you know if your card is rated below V30/UHS-3 or if your card has degraded over time and can no longer perform up to its standards.







Resetting Your Camera

RESTARTING YOUR GOPRO

If your camera is not responding, press and hold the Status/Pair button  for 10 seconds before releasing the button. This will restart your camera. There will be no changes to your settings.

RESTORING FACTORY SETTINGS

Factory Reset will restore all of your camera's original settings, clear all device connections, and deregister your camera from GoPro subscription. This is useful if you're giving your camera to a friend and want to completely reset it to its original state.

1. Press the Status/Pair button  to turn on your camera.
2. Press the Status/Pair button again to go to your camera's preferences (press twice if you're using Pro Controls).
3. Press the Shutter button  repeatedly until you get to Factory Reset.
4. Press the Status/Pair button to select Factory Reset.
5. Press the Status/Pair button to cycle from the  to the 
(or press the Shutter button with the  highlighted to go back).
6. Press Shutter button (with  highlighted) to confirm that you want to reset your camera.

Heads Up: Restoring the factory settings will not delete any content from your SD card or have any effect on your camera's software. You will, however, have to set up Auto-Upload to the cloud again.

For more, see [Using Buttons to Adjust Camera Preferences](#) (page 65).

Mounting Your GoPro



1



2



3

MOUNTING HARDWARE

1. Mounting Buckle
2. Thumb Screw
3. Curved Adhesive Mount

Mounting Your GoPro

Your camera has two sets of mounting fingers. Depending on the mount you're using, you'll either use a mounting buckle or attach your GoPro directly to the mount itself.

BOTTOM MOUNTING FINGERS

Use the bottom mounting fingers to attach your GoPro to grips, tripods, and gear mounts.

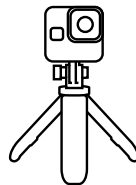

REAR MOUNTING FINGERS

Use the back mounting fingers when you want a more low-profile mounting option, including helmet mounts.

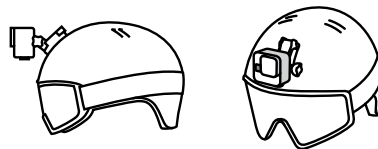

Mounting Your GoPro

USING THE MOUNTING FINGERS

1. Flip the folding fingers down into the mounting position.



Interlock the folding fingers on your camera with the mounting fingers on the buckle.

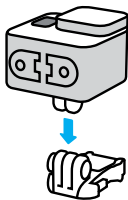

WARNING: The mounting fingers may get hot during extended recording sessions. Use caution when removing your camera from a mount or adjusting mounting locations.

Mounting Your GoPro

2. Secure your camera to the mounting buckle with a thumb screw.

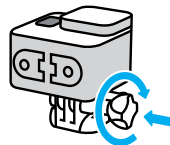

3. Attach the mounting buckle to the mount.
 - a. Flip up the mounting buckle plug.
 - b. Slide the buckle into the mount until it clicks into place.
 - c. Press the plug back down so that it sits flush with the buckle.

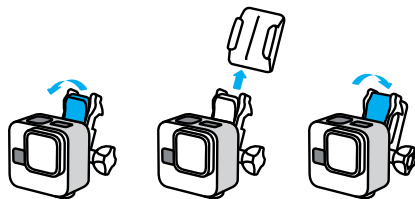

See *Using the Adhesive Mounts* (page 52) for tips on using adhesive mounts.

Mounting Your GoPro

USING THE ADHESIVE MOUNTS

Follow these guidelines when attaching adhesive mounts to helmets, vehicles, and gear:

- Attach mounts at least 24 hours before you use them.
- Only attach the mounts to smooth surfaces. They won't stick properly to porous or textured surfaces.
- Firmly press mounts into place. Be sure the adhesive is in full contact with the surface.
- Only use on clean, dry surfaces. Wax, oil, dirt, or other debris will weaken the bond, and you could lose your camera.
- Attach mounts in dry, room-temperature conditions. They won't stick properly in cold or damp environments or on cold or damp surfaces.
- Check state and local regulations and laws to ensure that attaching a camera to equipment (such as hunting gear) is permitted. Always comply with regulations that restrict the use of consumer electronics or cameras.



WARNING: To avoid injury, do not use a tether when mounting your camera on a helmet. Do not mount the camera directly on skis or snowboards.

For more information about mounts, visit [GoPro.com](https://www.gopro.com).

Mounting Your GoPro

WARNING: Always use a helmet that meets applicable safety standards if you're using a GoPro helmet mount or strap.

Choose the right helmet for your sport or activity, and make sure that it's the right size and fit for you. Check to see that your helmet's in good condition, and always follow the manufacturer's instructions on safe use.

Replace any helmet that's been subjected to a major impact. No helmet can protect against injury in every accident. Be safe.

USING YOUR GOPRO IN + AROUND WATER

Your GoPro is waterproof to 33ft (10m) with the door locked. You won't need an additional housing before diving in.

Although you cannot use the GoPro Quik app to adjust modes and settings under water, you can use the camera's buttons to navigate the menus when you're submerged. To learn more, see [Navigating with the Camera Buttons](#) (page 61).

PRO TIP: Use a camera tether and a Floaty (sold separately) to keep your camera afloat in case it detaches from the mount. The Handler (Floating Hand Grip) was also made to keep your GoPro afloat.

For more information on Camera Tethers, Floaty, and The Handler, visit [GoPro.com](https://www.gopro.com).

Removing the Door

There might be times when you need to remove your camera's door.

NOTE: Only remove the door in a dry, dust-free environment. The camera is not waterproof when the door is open or removed.

REMOVING THE DOOR

1. Unlock the latch, and flip the door open.
2. With the door in a horizontal position, gently pull outward until it snaps off.

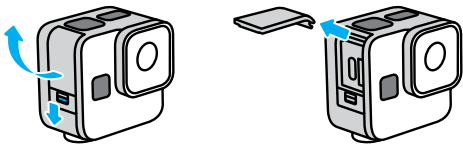

WARNING: Avoid using your GoPro with the door off. This will expose the USB port and SD card and leave your camera vulnerable to water damage.

Removing the Door

REATTACHING THE DOOR

1. Line the door up with the small silver bar.
2. Press the door tightly into the small silver bar until it snaps into place and is securely attached.

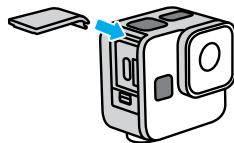

WARNING: Your camera's door is removable. Be sure that the door is securely locked and sealed after closing. An unsealed door will leave your camera vulnerable to water damage.

Maintenance

Follow these tips to get the best performance from your camera:

- Your GoPro is waterproof to 33ft (10m)—no housing needed. Be sure the door is closed before using it in or around water, dirt, or sand.
- Before closing the door, be sure the seal is free of debris. Use a cloth to clean the seal if needed.
- Make sure your GoPro is dry and clean before opening the door. Rinse your camera with fresh water and dry it with a cloth if needed.
- If sand or debris hardens around the door, soak your camera in warm tap water for 15 minutes and then rinse thoroughly to remove the debris. Make sure your camera is dry before opening the door.
- For the best audio performance, shake your camera or blow on the mic to remove water and debris from the microphone holes. Do not use compressed air to blow into the mic holes. This could damage the internal waterproof membranes.
- After every use in salt water, rinse your camera with fresh water, and dry it with a soft cloth.
- The removable lens cover is made from extremely tough strengthened glass, but it can still be scratched or cracked. Keep it clean with a soft, lint-free cloth.
- If debris gets stuck between the lens and trim ring, flush it out with water or air. Do not insert foreign objects around the lens.

Battery Information

Your camera and battery are integrated. You cannot remove the battery from the camera. The battery is non-serviceable. Contact GoPro Customer Service for all battery related issues.

MAXIMIZING BATTERY LIFE

The battery icon displayed in the camera status screen blinks and shows a low battery message when the battery drops below 10%. If the battery reaches 0% while recording, the camera saves the file and powers off.

Here are some things you can do to maximize battery life:

- Use the Easy Controls' Extended Battery or Longest Battery mode.
- Switch to lower frame rates and resolutions using Pro Controls.

RECORDING WHEN PLUGGED INTO A POWER SOURCE

You can use the USB-C cable that came with your camera to record while your camera is plugged in to a USB-charging adapter or other external power source. This is perfect for capturing long videos and time lapse events.

Be careful not to touch the area near the SD card slot when recording. Disturbing the SD card could interrupt or stop the recording. Your camera will let you know if this happens. Your content will not be damaged or lost as a result of this disturbance, but you may need to restart your camera to continue.

Heads Up: Even though your camera is charging, the battery will not charge during recording. It will start charging when you stop recording. You cannot record while your camera is plugged into a computer.

Heads Up: Because the door is open, your camera is not waterproof when charging.

Battery Information



WARNING: Using a non-GoPro wall charger or power cable could damage your camera battery and could lead to fire or leakage. With the exception of the GoPro Supercharger, only use chargers marked Output 5V 1A. If you don't know your charger's voltage and current, use the included USB-C cable to charge your camera with a computer.

BATTERY STORAGE + HANDLING

Your GoPro is full of sensitive components, including the battery. Avoid exposing your camera to very hot or cold temperatures. Extreme temperatures may temporarily shorten battery life or cause your camera to temporarily stop working properly. Avoid dramatic temperature or humidity changes, as condensation may form on or within the camera.

Do not dry your camera with an external heat source such as a microwave oven or a hair dryer. Damage to the camera or battery caused by contact with liquid inside the camera is not covered under the warranty.

Do not make any unauthorized alterations to your camera. Doing so may compromise safety, regulatory compliance, and performance, and may void the warranty.

Heads Up: Batteries have reduced capacity in cold weather. Maximize battery life in cold conditions by keeping your camera in a warm place before use.

PRO TIP: Fully charge your camera before storing it away to help maximize battery life.

Battery Information



WARNING: Do not drop, disassemble, open, crush, bend, deform, puncture, shred, microwave, incinerate, or paint your camera or battery. Do not insert foreign objects into any opening on the camera, such as the USB-C port. Do not use your camera if it's been damaged—for example, if cracked, punctured, or harmed by water. Disassembling or puncturing the integrated battery can cause an explosion or fire.

BATTERY DISPOSAL

Most rechargeable lithium-ion batteries are classified as non-hazardous waste and are safe for disposal in the normal municipal waste stream. Many regions require battery recycling. Check your local laws to make sure that you can dispose of your camera and its battery in your regular trash.

Lithium-ion batteries, however, do contain recyclable materials and are accepted for recycling by the Rechargeable Battery Recycling Corporation's (RBR) Battery Recycling Program. We encourage you to visit Call2Recycle.org or call 1-800-BATTERY in North America to find a convenient recycling location.

Never dispose of a battery in a fire because it may explode.

Troubleshooting

MY GOPRO WON'T POWER ON

Make sure your GoPro is charged. See [SD Card + Battery Setup](#) (page 10). If charging the battery doesn't work, try restarting your camera.

See [Restarting Your GoPro](#) (page 47).

MY GOPRO WON'T RESPOND WHEN I PRESS A BUTTON



See [Restarting Your GoPro](#) (page 47).

PLAYBACK ON MY COMPUTER IS CHOPPY



Choppy playback is usually not a problem with the file. If your footage skips, one of these issues is probably the cause:

- The computer doesn't work with HEVC files. Try downloading the latest version of the GoPro Player for Mac® or Windows® for free at [GoPro.com/apps](#).
- Your computer doesn't meet the minimum requirements of the software you're using for playback.

I FORGOT MY CAMERA'S USERNAME OR PASSWORD

1. Tap   after connecting to the GoPro Quik app.
2. Scroll down to Camera Info.

I DON'T KNOW WHICH SOFTWARE VERSION I HAVE

1. Tap   after connecting to the GoPro Quik app.
2. Scroll down to Camera Info.

For more, see [Your Camera's Software Version](#) (page 16).

I CAN'T FIND MY CAMERA'S SERIAL NUMBER

The serial number is stamped inside the door of your camera.

For more, see [Your Camera's Software Version](#) (page 16).

STILL NEED HELP?

For more answers to commonly asked questions, see [GoPro.com/help](#).

Navigating With the Camera Buttons

USING BUTTONS TO SWITCH VIDEO MODES (EASY CONTROLS)

1. Press the Status/Pair button  to turn on your camera.



2. Press the Status/Pair button again to go to your camera's preferences.



3. Press the Shutter button  to access Video Modes.



4. Press the Status/Pair button repeatedly to cycle through video modes: Extended Battery > Longest Battery > Highest Quality.

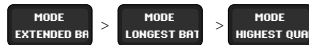

5. Press the Shutter button to lock in the mode of your choice.
6. Press the Shutter button to pass through the remaining options and exit to the capture screen.

Navigating With the Camera Buttons

USING BUTTONS TO SWITCH VIDEO MODES (PRO CONTROLS)

1. Press the Status/Pair button  to turn on your camera.



2. Press the Status/Pair button again to go to your camera's Video Settings.



3. Press the Shutter button  to access Capture Modes: Video Settings > Mode.



4. Press the Status/Pair button repeatedly to cycle through Capture Modes: Video > TimeWarp > Star Trails > Light Painting > Vehicle Light Trails > Time Lapse > Night Lapse.



5. Press the Shutter button to lock in the mode of your choice.
6. Press the Shutter button to pass through the remaining options and exit to the capture screen.

Navigating With the Camera Buttons

USING BUTTONS TO ADJUST SETTINGS WITH PRO CONTROLS

1. Press the Status/Pair button  to turn on your camera.



2. Press the Status/Pair button again to go to your camera's Video Settings.



3. Press the Shutter button  to access Video Capture Modes.



4. Use the Status/Pair button to cycle through your options. Stop on the mode that you want to adjust and press the Shutter button to lock it in.



Navigating With the Camera Buttons

5. Press the Shutter button repeatedly to cycle through the settings for that mode. Stop on the setting you want to adjust. Settings vary by mode:

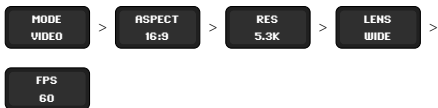

- Video: Aspect (Aspect Ratio) > Res (Resolution) > Lens > FPS
 - TimeWarp: Aspect (Aspect Ratio) > Res (Resolution) > Lens > Speed
 - Star Trails, Light Painting, and Vehicle Light Trails: Aspect (Aspect Ratio) > Res (Resolution) > Trail Length > Shutter
 - Time Lapse: Aspect (Aspect Ratio) > Res (Resolution) > Lens > Interval
 - Night Lapse: Aspect (Aspect Ratio) > Res (Resolution) > Lens > Shutter > Interval
6. Press the Status/Pair button to cycle through the options for that setting.
 7. Press the Shutter button to lock in the setting that you want.
 8. Press the Shutter button to pass through the remaining options and exit to the capture screen.

Navigating with the Camera Buttons

USING BUTTONS TO ADJUST CAMERA PREFERENCES

1. Press the Status/Pair button  to turn on your camera. Press the Status/Pair button again to go to your camera's preferences if you are using Easy Controls.



Press twice if you're using Pro Controls: Video Settings > Preferences.



2. Press the Shutter button  repeatedly to see your preference options. Stop on the one that you want to adjust.
For Easy Controls: Mode > Controls > Pairing > Format SD > Factory Reset > About



For Pro Controls: Controls > Pairing > Format SD > Factory Reset > About



Navigating With the Camera Buttons

3. Press the Status/Pair button repeatedly to see your preferences settings options.
4. Press the Shutter button to lock in the setting that you want.
5. Press the Shutter button to pass through the remaining options and exit to the capture screen setting.

Tech Specs

VIDEO RESOLUTION (RES)

Video resolution refers to the number of horizontal lines used in each frame of video. A 1080p video is made up of 1080 horizontal lines. A 5.3K video is made up of 5312 horizontal lines. Since more lines equals greater resolution, 5.3K will deliver a more detailed picture than 1080p.

Video Resolution	Description
5.3K 16:9	Ultra high-resolution video that captures breathtaking ultra HD video in the wide 16:9 aspect ratio. Can be used to grab 15.8MP stills from your video.
5.3K 4:3	Ultra high-resolution video that captures more of the scene with the taller 4:3 aspect ratio. Great for point-of-view footage and grabbing 21MP stills from your video.
5.3K 8:7	Ultra high-resolution video that captures the tallest and widest field of view ever on a HERO camera. Great for zooming in while keeping the rich textures and sharpness of your footage and grabbing 24.7MP stills from your video.
4K 4:3	Ultra HD video with tall 4:3 aspect ratio captures more of the scene than 16:9 shots. Can be used to grab 12MP stills from your video.
4K 16:9	Ultra HD video with 16:9 aspect ratio. Great for tripod and fixed-position shots. Can be used to grab 8MP stills from your video.

Tech Specs

Video Resolution	Description
4K 8:7	Ultra HD video in the extra tall and wide 8:7 aspect ratio. Great for capturing immersive POV footage that lets you change digital lenses, crop your shot, and adjust aspect ratios after recording. Can be used to grab 12.9MP stills from your video.
2.7K 4:3	Great for high-resolution point-of-view body and gear-mounted shots with fluid slo-mo playback.
2.7K 16:9	High resolution 16:9 video that provides stunning, cinema-quality results for professional productions. High 240 fps and 120 fps options enable super slo-mo during editing.
1080p	Standard HDTV resolution that's great for all shots and sharing to social media. High 240 fps and 120 fps options enable super slo-mo during editing.

Heads Up: Only the resolutions that are compatible with the aspect ratio you selected will be available.

Tech Specs

FRAMES PER SECOND (FPS)

Frames per second refers to the number of frames captured in each second of video. Higher fps values (60, 120, or 240) are better at capturing fast-action shots. You can also use high fps footage for slo-mo playback.

Slo-Mo + FPS

Normal speed video is typically captured and played back at 30 fps. As a result, video that is captured at 60 fps can be played back at 2x slow motion (1/2 speed). Video that is recorded at 120 fps can be played back at 4x slow motion (1/4 speed) and video recorded at 240 fps can be played back at 8x slow motion (1/8 speed).

Videos recorded at higher fps will also have more fluid motion with greater detail when watched in slow motion.

Resolution + FPS

Higher video resolutions capture more detail and clarity, but they're generally available at lower fps values.

Lower video resolutions capture less detail and clarity, but they can be shot at higher fps values.

Heads Up: Only the frame rates that are compatible with the resolution and lens you selected will be available.

Tech Specs

HIGH RESOLUTIONS + FRAME RATES

Shooting high-resolution or high-fps video when it's warm out can cause your camera to heat up and use more power.

Lack of airflow and connecting to the GoPro Quik app can cause your camera to warm up even more, use even more power, and shorten recording time.

How to Keep Your Camera from Getting Too Hot

Your camera was designed to be cooled by airflow. For the longest possible runtime, make sure there is enough air circulating around your camera while it's recording. It will automatically shut down if it gets too hot. Simply let it cool down before using it again.

If heat is still a problem, try recording shorter videos. Also limit use of features that take a lot of power, such as the GoPro Quik app. The Remote (sold separately) can control your GoPro while using less energy.

Your camera will tell you if it needs to shut down and cool off. To learn more, see [Important Messages](#) (page 44).

Tech Specs

ASPECT RATIO (VIDEO)

Aspect ratio refers to the width and height of an image. Your GoPro captures videos three aspect ratios.

16:9

This is the standard format used for HDTV and editing programs. The widescreen format is ideal for capturing dramatic, cinematic footage.

4:3

The tall 4:3 format captures more of the scene than the 16:9 widescreen format. It's great for selfies and point-of-view footage.

8:7

This ultra immersive format is the tallest and widest field of view ever on a GoPro HERO camera—allowing you to capture more of the scene in each shot. This lets you zoom in and focus on chosen sections of your footage to create high-resolution punchouts of the action in any aspect ratio while cropping out the rest of the shot using the GoPro Quik app or other editing software.

Heads Up: Black bars will appear on both sides of the screen when playing back 4:3 and 8:7 footage on an HDTV.

Tech Specs

DIGITAL LENSES (VIDEO)

Digital lenses let you choose how much of the scene is captured by your camera. The different lenses also affect the zoom level and the fisheye effect in your shot.

Digital Lens	Description
HyperView (12mm)	Our tallest and widest field of view in ultra immersive 16:9 video. <i>Heads Up:</i> HyperView stretches 8:7 footage to fit a 16:9 screen. The result is ultra immersive footage with a fish-eye effect. It's best used for POV action sports footage rather than general recording.
SuperView (16mm)	Serves up tall 4:3 aspect ration footage as immersive 16:9 video.
Wide (16–34mm)	Wide field of view that captures as much as possible within the frame.
Linear + Horizon Lock / Horizon Leveling (19–33mm)	Captures a wide field of view without the fisheye effect of HyperView, SuperView, or Wide. Keeps your footage smooth and level even if your camera rotates while recording. To learn more, see Horizon Lock / Horizon Leveling (page 76).
Linear (19–39mm)	Wide field of view without the fisheye effect of SuperView and Wide.

Heads Up: Only the lenses that are compatible with the aspect ratio and resolution you selected will be available.

Tech Specs

VIDEO MODE SETTINGS

Here's a full rundown of your camera's video resolutions, frame rates (fps), digital lenses, and aspect ratios.

Video Resolution (RES)	FPS (60Hz/50Hz)*	Digital Lenses	Screen Resolution	Aspect Ratio
5.3K	60/50	SuperView, Wide, Linear, Linear + Horizon Leveling	5312x2988	16:9
5.3K	30/25 24/24	HyperView, SuperView, Wide, Linear, Linear + Horizon Lock	5312x2988	16:9
5.3K 4:3	30/25 24/24	Wide, Linear, Linear + Horizon Lock	5312x3984	4:3
5.3K 8:7	30/25	Wide	5312x4648	8:7

*60Hz (NTSC) and 50Hz (PAL) refer to the video format, which depends on your region. To learn more, see [Anti-Flicker](#) (page 23).

Tech Specs

Video Resolution (RES)	FPS (60Hz/50Hz)*	Digital Lenses	Screen Resolution	Aspect Ratio
4K	120/100	SuperView, Wide, Linear, Linear + Horizon Leveling	3840x2160	16:9
4K	60/50	HyperView, SuperView, Wide, Linear, Linear + Horizon Lock	3840x2160	16:9
4K	30/25 24/24	SuperView, Wide, Linear, Linear + Horizon Lock	3840x2160	16:9
4K 4:3	60/50 30/25 24/24	Wide, Linear, Linear + Horizon Lock	4000x3000	4:3
4K 8:7	60/50	Wide	5312x4648	8:7
2.7K	240/200	Wide, Linear, Linear + Horizon Leveling	2704x1520	16:9
2.7K	120/100 60/50	SuperView, Wide, Linear, Linear + Horizon Lock	2704x1520	16:9

Tech Specs

Video Resolution (RES)	FPS (60Hz/50Hz)*	Digital Lenses	Screen Resolution	Aspect Ratio
2.7K 4:3	120/100 60/50	Wide, Linear, Linear + Horizon Lock	2704x2028	4:3
1080p	240/200	Wide, Linear, Linear + Horizon Leveling	1920x1080	16:9
1080p	120/100 60/50 30/25 24/24	SuperView, Wide, Linear, Linear + Horizon Lock	1920x1080	16:9

*60Hz (NTSC) and 50Hz (PAL) refer to the video format, which depends on your region. To learn more, see [Anti-Flicker](#) (page 23).

Tech Specs

LINEAR + HORIZON LOCK / HORIZON LEVELING DIGITAL LENS

Your GoPro can give your videos the cinematic look of professional productions by keeping the horizon straight and level. Depending on the resolution and frame rate, your camera will record with either Horizon Lock or Horizon Leveling.

PRO TIP: Combine Horizon Control with HyperSmooth for ultimate video stabilization.

Horizon Lock

The Linear + Horizon Lock digital lens keeps your footage locked and steady (on the horizontal or vertical axis) even if your camera rotates a full 360° while recording. It's available when recording 16:9 and 4:3 aspect ratio footage using most frame rates at each resolution.

Horizon Leveling

The Linear + Horizon Leveling digital lenses keep your footage smooth and level even if your camera tilts while recording. They're available when recording 16:9 aspect ratio footage at the highest frame rate of each resolution (5.3K60, 4K120, 2.7K240, and 1080p240).

Video Resolution (RES)	FPS (60Hz/50Hz)*	Digital Lens	Aspect Ratio
5.3K	60/50	Linear + Horizon Leveling	16:9
5.3K	30/25 24/24	Linear + Horizon Lock	16:9
5.3K 4:3	30/25 24/24	Linear + Horizon Lock	4:3

Tech Specs

Video Resolution (RES)	FPS (60Hz/50Hz)*	Digital Lens	Aspect Ratio
4K	120/100	Linear + Horizon Leveling	16:9
4K	60/50 30/25 24/24	Linear + Horizon Lock	16:9
4K 4:3	60/50 30/25 24/24	Linear + Horizon Lock	4:3
2.7K	240/200	Linear + Horizon Leveling	16:9
2.7K	120/100 60/50	Linear + Horizon Lock	16:9
2.7K 4:3	120/100 60/50	Linear + Horizon Lock	4:3
1080p	240/200	Linear + Horizon Leveling	16:9
1080p	120/100 60/50 30/25 24/24	Linear + Horizon Lock	16:9

Heads Up: Horizon Lock/Leveling is not available when recording 8:7 aspect ratio footage.

*60Hz (NTSC) and 50Hz (PAL) refer to the video format, which depends on your region. To learn more, see [Anti-Flicker](#) (page 23).

Tech Specs

HYPERSMOOTH VIDEO STABILIZATION

HyperSmooth delivers ultra smooth footage by correcting for camera shake. It crops your videos while recording, which lets it buffer the footage. This makes it perfect for biking, skating, skiing, handheld shots, and more. Your GoPro has four HyperSmooth settings. The default setting is On.

Setting	Description
AutoBoost	Combines maximum video stabilization with the widest field of view possible. Cropping varies based on the level of stabilization required for the shot.
Boost	Maximum video stabilization with tight cropping.
On	High-level video stabilization with minimal cropping.
Off	Records without video stabilization or cropping.

You can smooth out your footage even more by using the Linear + Horizon Lock and Linear + Horizon Leveling digital lenses when recording with HyperSmooth.

Heads Up: You can only change your HyperSmooth setting using the GoPro Quik app.

PRO TIP: Use Max Lens Mod (sold separately) to max out your GoPro with the ultimate in unbreakable video stabilization up to 2.7K60.

Tech Specs

TIMEWARP VIDEO SPEED

You can increase TimeWarp video speed up to 30x to turn longer activities into shareable moments. The default setting is Auto, which automatically sets the speed for you.

You can also set the speed yourself. Use this chart to estimate the length of your videos. For example, recording at 2x speed for 4 minutes will give you about 2 minutes of TimeWarp video.

Speed	Recording Time	Video Length
2x	1 minute	30 seconds
5x	1 minute	10 seconds
10x	5 minutes	30 seconds
15x	5 minutes	20 seconds
30x	5 minutes	10 seconds

Heads Up: Recording times are approximate. The video length may vary depending on the movement in your shot.

Speed	Examples
2x–5x	Driving through a scenic route.
10x	Hiking and exploring.
15x–30x	Running and mountain biking.

PRO TIP: For the best results, leave the speed on the Auto setting when shooting footage that may get bumpy.

Tech Specs

VIDEO RESOLUTION (TIMEWARP, TIME LAPSE VIDEO)

HERO11 Black Mini shoots TimeWarp and Time Lapse in three resolutions and aspect ratios:

Resolution	Aspect Ratio
5.3K	16:9
4K	16:9
4K	4:3
1080p	16:9

To learn more, see:

- [Video Resolution \(RES\)](#) (page 67)
- [Aspect Ratio \(Video\)](#) (page 71)

Tech Specs

INTERVAL (TIME LAPSE)

The Interval sets how often your camera takes a shot in Time Lapse mode.

Available intervals are 0.5 (default), 1, 2, 5, 10, 30, and 60 seconds; 2, 5, and 30 minutes; and 1 hour.

Interval	Examples
0.5–2 seconds	Surfing, biking, or other sports.
2 seconds	Busy street corner.
5–10 seconds	Clouds or outdoor scenes for long durations.
10–60 seconds	Art projects or other lengthy activities.
60 seconds–1 hour	Construction work or other activities that take place over a very long period of time.

Tech Specs

TIME LAPSE VIDEO RECORDING TIME

Use this chart to determine the length of your videos.

Interval	Recording Time	Video Length
0.5 second	5 minutes	20 seconds
1 second	5 minutes	10 seconds
2 seconds	10 minutes	10 seconds
5 seconds	1 hour	20 seconds
10 seconds	1 hour	10 seconds
30 seconds	5 hours	20 seconds
60 seconds	5 hours	10 seconds
2 minutes	5 hours	5 seconds
5 minutes	10 hours	4 seconds
30 minutes	1 week	10 seconds
1 hour	1 week	5 seconds

Tech Specs

SHUTTER (STAR TRAILS, LIGHT PAINTING, VEHICLE LIGHT TRAILS, NIGHT LAPSE)

Shutter speed lets you decide how long your camera's shutter stays open when you're using the night capture modes. Use longer exposures in darker environments to let in more light for your shot.

The shutter speeds for Star Trails and Vehicle Light Trails are 0.5, 1, 2, 5, 10 and 30 seconds. The shutter speeds for Light Painting are 0.5, 1, and 2 seconds.

Here are the options for Night Lapse, plus tips on when to use them:

Shutter Speed	Examples
Auto	Sunrise, sunset, dawn, dusk, twilight, night.
2, 5, 10, or 15 seconds	Dawn, dusk, twilight, traffic at night, Ferris wheel, fireworks, light painting.
20 seconds	Night sky (with light).
30 seconds	Night stars, Milky Way (complete darkness).

PRO TIP: To reduce blur when capturing night and low-light footage, mount your camera on a tripod or place it on a stable surface where it won't wobble or shake.

Tech Specs

INTERVAL (NIGHT LAPSE)

Choose how often your GoPro snaps a shot in Night Lapse mode. Night Lapse intervals are Auto; 4, 5, 10, 15, 20, 30, and 60 seconds; 2, 5, 30, and 60 minutes.



Auto (default) syncs the Interval with the Shutter setting. If the shutter speed is set to 10 seconds and the Interval is set to Auto, your camera will take a shot every 10 seconds.

Interval	Examples
Auto	Great for all exposures (captures as quickly as possible depending on the Shutter setting).
4–5 seconds	Evening city scene, street lighting, or scenes with movement.
10–15 seconds	Dim lighting with slow scene changes, such as night clouds with a bright moon.
20–30 seconds	Very low light or very slow scene changes, like stars with minimal ambient or street light.

Protune

Protune unlocks your camera's full creative potential by giving you manual control of advanced settings, including Color, White Balance, and Shutter Speed. It's compatible with professional color correction tools and other editing software.

Connect to the GoPro Quik app adjust Protune settings.

1. Tap  on the app screen.
2. Tap  next to the mode that you want to adjust.
3. Tap the setting to make adjustments.

Changes to Protune settings in one capture mode apply only to that mode. For example, changing the White Balance for TimeWarp does not affect White Balance for Time Lapse.

PRO TIP: You can restore all Protune settings to their defaults by tapping Reset Protune in the app.

10-BIT HEVC

10-bit video can display over 1 billion colors for enhanced color depth in your footage. Turn this setting on to save your videos in the 10-bit HEVC format.

Heads Up: Be sure that your devices are capable of playing back 10-bit HEVC content before using this setting.

BIT RATE

Bit rate determines the amount of data used to record a second of video. Choose between standard or high.

Bit Rate	Description
Standard (default)	Use a lower bit rate to minimize file sizes.
High	Use higher bit rates up to 120Mbps (5.3K and 4K video) for optimal image quality.

Protune

COLOR

Color lets you adjust the color profile of your videos. Scroll between the options to see a live preview of each setting, and then tap the one you want.

Color Setting	Description
Natural (default)	Captures video with a true-to-life color profile.
Vibrant	Captures video with a color-saturated profile.
Flat	Provides neutral color profile that can be color-corrected to better match footage captured with other equipment, offering more flexibility in post-production. Due to its long curve, Flat captures more details in shadows and highlights.

WHITE BALANCE

White Balance lets you adjust the color temperature of your footage to optimize for cool or warm lighting conditions. Scroll between the options to see a live preview of each setting, and then tap the one you want.

Options for this setting are Auto (default), 2300K, 2800K, 3200K, 4000K, 4500K, 5000K, 5500K, 6000K, 6500K, and Native. Lower values will give you warmer tones.

You can also choose Auto to let your GoPro set the White Balance or the Native setting to create a minimally color-corrected file that allows for more precise adjustments in post-production.

Protune

ISO MINIMUM/MAXIMUM

ISO Minimum and ISO Maximum let you set a range for the camera's sensitivity to light and image noise. Image noise refers to the degree of graininess in the shot.

In low light, higher ISO values result in brighter images but with more image noise. Lower values result in darker images with less image noise. Scroll between the options to see a live preview of each setting, and then tap the one you want.

The default for ISO Maximum is 1600, while the default for ISO Minimum is 100.

ISO Maximum and Minimum can also be set to Auto when recording video. This is especially useful when shooting in environments with fluctuating lighting conditions.

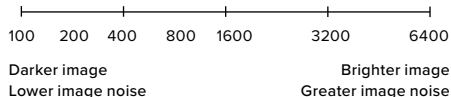

Heads Up: ISO behavior depends on the Protune Shutter setting. The ISO Maximum that you select is used as the maximum ISO value. The ISO value that is applied might be lower depending on the lighting conditions.

PRO TIP: To lock the ISO at a specific value, set ISO Minimum and ISO Maximum to the same values.

Protune

SHUTTER

The Protune Shutter setting determines how long the shutter stays open. Scroll between the options to see a live preview of each setting, and then tap the one you want. The default setting is Auto.

The options depend on the fps setting, as shown below.

Shutter	Example 1: 1080p30	Example 2: 1080p60
Auto	Auto	Auto
1/fps	1/30 sec	1/60 sec
1/(2xfps)	1/60 sec	1/120 sec
1/(4xfps)	1/120 sec	1/240 sec
1/(8xfps)	1/240 sec	1/480 sec
1/(16xfps)	1/480 sec	1/960 sec

PRO TIP: To reduce the amount of blur when using the Shutter setting, mount your camera on a tripod or other stable surface where it won't wobble or shake.

Protune

EXPOSURE VALUE COMPENSATION (EV COMP)

Exposure Value Compensation affects the brightness of your videos. Adjusting this setting can improve image quality when shooting scenes with sharply contrasting lighting conditions.

Options for this setting range from -2.0 to +2.0. The default setting is 0.0.

Scroll between the options on the right side of the EV Comp screen to see a live preview of each setting, and then tap the one you want. Higher values result in brighter images.

Heads Up: For Video, this setting is available only if Shutter is set to Auto.

PRO TIP: EV Comp adjusts brightness within the existing ISO setting. If brightness has already reached the ISO setting in a low-light environment, increasing the EV Comp does not have any effect. To continue increasing the brightness, select a higher ISO value.

Protune

SHARPNESS

Sharpness controls the quality of details captured in your video footage. Options for this setting are High, Medium (default), and Low.

PRO TIP: If you plan to increase sharpness during editing, select Low for this setting.

Protune

RAW AUDIO

This setting creates a separate .wav file for your video, in addition to the standard .mp4 audio track. You can select the level of processing to apply to the RAW audio track.

RAW Setting	Description
Off (default)	No separate .wav file is created.
Low	Applies minimal processing. Ideal if you want to apply audio processing in post-production.
Med	Applies moderate processing based on the Wind-Noise Reduction setting. Ideal if you want to apply your own gain.
High	Applies full audio processing (automatic gain and Wind-Noise Reduction). Ideal if you want processed audio without AAC encoding.

Insert your SD card into a card reader to access the .wav files with your computer. They're saved with the same name and in the same location as the .mp4 files.

Protune

WIND-NOISE REDUCTION

Your HERO11 Black Mini uses three microphones to capture sound while recording video. You can customize how they're used based on conditions where you're shooting and the type of sound you want in your finished video.

Setting	Description
Auto (default)	Automatically filters out excessive wind noise.
On	Use to filter out excessive wind noise or when your GoPro is mounted on a moving vehicle.
Off	Use when wind will not affect sound quality and you want to ensure that your GoPro is recording in stereo.

Customer Support

GoPro is dedicated to providing the best possible service. To reach GoPro Customer Support, visit GoPro.com/help.

Trademarks

GoPro, HERO and their respective logos are trademarks or registered trademarks of GoPro, Inc. in the United States and other countries. © 2022 GoPro, Inc. All rights reserved. For patent information, visit GoPro.com/patents. GoPro, Inc., 3025 Clearview Way, San Mateo CA 94402 | GoPro GmbH, Baierbrunner Str. 15 Bldg. D, 81379 Munich, Germany

Regulatory Information

To see the complete list of country certifications, refer to the Important Product + Safety Instructions included with your camera or visit GoPro.com/help.

